



METAL HANDLING







Your Safety Our Priority

The Company

Our History

The story of Sall began in 1975 in Caviago, in a small artisanal workshop specialising in metalworking and the production of industrial containers. During the 1980s, the company expanded its product range by designing innovative solutions for workplace safety. This unstoppable growth led to Sall's acquisition by Justrite Safety Group in 2017, a global leader in industrial safety.

Our Priorities

- Ensuring the safety of people and the environment
- Products compliant with EU standards and regulations
- Comfort, ease of use, and unique design to enhance effectiveness and simplify every operation.

All our standard products and customised solutions are designed and manufactured in compliance with current regulations and are tested to provide the highest level of safety for people, workplaces, and the environment.

The Group

A Growing Family

In recent years, we have expanded Justrite Safety Group by acquiring other strong and valuable companies. These exciting developments have resulted in: an unrivalled safety portfolio, consolidated expertise in environmental protection, a global network of brands, and unwavering dedication to the safety of our customers.

Start with the Essential

The essence of our group is captured in a single slogan: *Start with the Essential*SM.

At Justrite, everything begins with safety. Protecting people, property, and the planet is our first and foremost responsibility.

Find out more on our website www.sall.it

Justrite Brands



PRODUCT INDEX BY CATEGORY



TIPPING CONTAINERS & BOTTOM-OPENING CONTAINERS

a. Tipping scrap containers

1. Tipping scrap containers with manual release.....	p.	7
2. Tipping scrap containers with dynamic release.....	p.	12
3. Mesh tipping scrap containers.....	p.	12
4. Tipping bins.....	p.	13
5. Tipping scrap containers for forklifts with rotating forks.....	p.	13

b. Bottom-opening containers

1. Containers with a single opening bottom panel.....	p.	15
2. Containers with double opening bottom panels.....	p.	16



CONTAINERS FOR INDUSTRY

a. Sheet metal containers

1. Steel sheet metal containers.....	p.	18
2. Sheet metal containers with flat bar skids.....	p.	22
3. Open-front containers.....	p.	22
4. Foldable, stackable sheet metal containers.....	p.	23
5. Foldable sheet metal containers with lids.....	p.	23

b. Mesh containers

1. Steel mesh containers.....	p.	25
2. Mesh containers with wheels.....	p.	29
3. Gitterbox model mesh containers.....	p.	30
4. Foldable, stackable mesh containers.....	p.	30
5. Foldable mesh side panels.....	p.	30
6. Multifunctional containers.....	p.	31



METAL PALLETS AND PLATFORMS

a. Open post pallets

1. Open post pallets with feet.....	p.	33
2. Open post pallets with skids.....	p.	33

3. Open post pallets with removable wooden deck.....	p.	34
4. Pallets with detachable posts.....	p.	34
5. Bar storage pallets.....	p.	35
6. Foldable, stackable pallets.....	p.	36
7. Sides for wooden pallets.....	p.	36
8. Fabric storage pallets.....	p.	36

b. Metal platforms

1. Metal platforms with 2 skids.....	p.	38
2. Metal platforms with 3 skids.....	p.	39
3. Reversible double-bottom metal platforms.....	p.	39

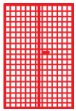

CABINETS AND STORAGE UNITS FOR GAS CYLINDERS

a. Boxes and storage units for gas cylinders

1. Safety storage units for compressed gas cylinders.....	p.	41
2. Safety cabinets for compressed gas cylinders.....	p.	42

b. Pallets for transporting gas cylinders

1. Pallets for transporting compressed gas cylinders.....	p.	44
2. Trolleys and supports for compressed gas cylinders.....	p.	44



CONTAINERS FOR WASTE COLLECTION

a. Big bag holders

1. Big bag holder pallets.....	p.	46
2. Big bag holders with collection tray.....	p.	49
3. Big bag holders with lid.....	p.	49

A black tipping scrap container is mounted on a forklift in a warehouse. The container has a lid with a black and white striped hazard pattern and several safety labels. The forklift is positioned in an aisle between metal shelving units filled with various items, including bags and containers. The background is slightly blurred, emphasizing the container in the foreground.

TIPPING CONTAINERS & BOTTOM- OPENING CONTAINERS

a. *Tipping scrap containers*

The ideal solution for the collection, transport, and disposal of industrial waste, shavings, scraps, and debris in a safe and efficient manner. All models in the Sall container line are equipped with safety features, including an anti-tipping mechanism and an automatic unloading system for forklift operations.

Tipping scrap containers

Tipping scrap containers with manual release



The best solution for the safe collection, handling, and unloading of waste, scraps, and debris.

- Simple and safe emptying system activated by a lever, remotely controlled by the operator (without leaving the forklift)
- Easy to manoeuvre and position thanks to four large diameter wheels (2 fixed, 2 swivel)
- Wide range of sizes available
- Consistent performance over time
- On request: settling tank and ball valve, removable or hinged lid, independent hydraulic cylinder for gradual tipping.



CE



A full range of colours is available, corresponding to the different types of waste.



Item code
LT 0300

Item code
LT 0500

Item code
LT 0750

Item code
LT 1000

Item code
LT 1350

**DIMENSIONS OF
FORKLIFT BOXES**

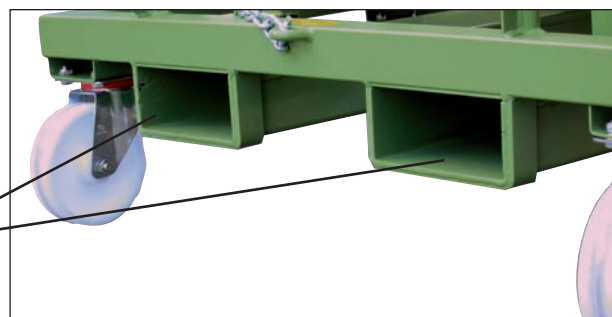
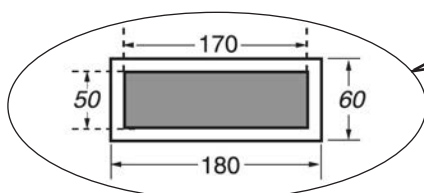

Tipping scrap containers

Tipping scrap containers with manual release

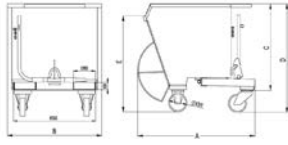

ITEM CODE	DIMENSIONS (mm)					Capacity (kg)	Volume (litres)
	A	B	C	D	E		
LT 0280	970	750	700	890	790	600	280

Item code
LT 0280

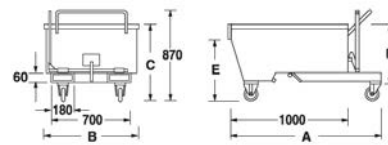

ITEM CODE	DIMENSIONS (mm)					Capacity (kg)	Volume (litres)
	A	B	C	D	E		
LT 0300	1350	820	650	490	520	600	285



Item code
LT 0300

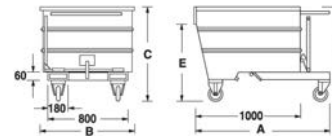

ITEM CODE	DIMENSIONS (mm)					Capacity (kg)	Volume (litres)
	A	B	C	D	E		
LT 0500	1350	920	910	700	740	1000	490
LT 0750	1350	1070	1040	825	800	1350	755



Products that comply with EU requirements regarding safety, health, and environmental protection.

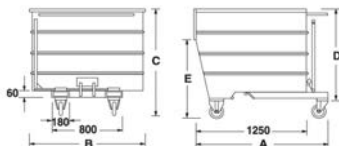

ITEM CODE	DIMENSIONS (mm)					Capacity (kg)	Volume (litres)
	A	B	C	D	E		
LT 1000	1550	1070	1210	970	920	1700	1070
LT 1350	1550	1320	1210	970	920	2000	1320
LT 1600	1550	1550	1210	970	920	2000	1610
LT 2000	1550	1950	1210	970	920	2000	2040



Item code
LT 1600



Tipping scrap containers

Tipping scrap containers with manual release

ACCESSORIES AVAILABLE UPON REQUEST:

1 SETTLING TANK WITH 4MM HOLE MESH GRID AND BALL VALVE FOR SEPARATING LIQUIDS FROM SOLIDS.

All tipping containers are equipped with:

- Sleeve
- 1" cap
- Nut and corresponding M12 closure bolt on the tank bottom.

At any time, it will be simple and immediate to:

- Unscrew the cap and discharge accumulated liquids
- Attach the ball valve (accessory available separately)
- Attach the settling grid (accessory available separately).

Item code
VR

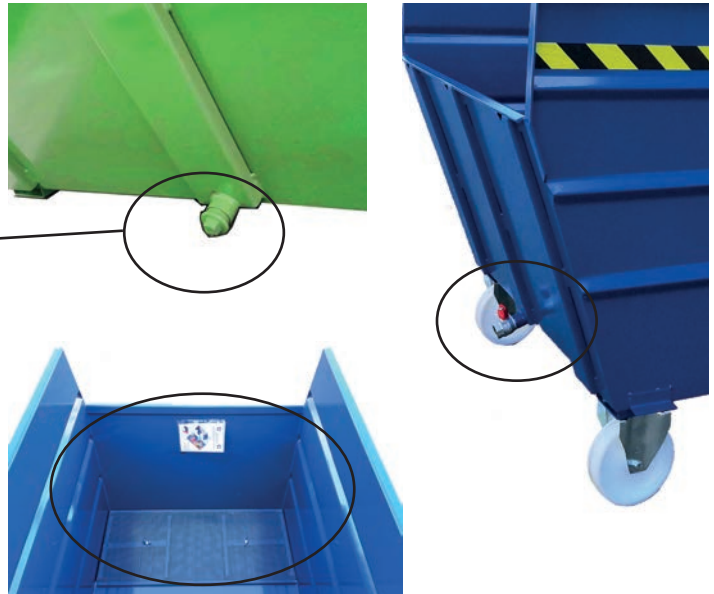

2 INDEPENDENT HYDRAULIC CYLINDER FOR GRADUAL TIPPING OF SCRAP CONTAINERS

The installation of the cylinders does not increase the dimensions, as they are mounted within the container's footprint.

For larger models, we recommend applying a hydraulic cylinder on both sides to ensure better balance during unloading.

For models from LT1600 to LT2000, the application of 2 hydraulic cylinders is required (see image **item code CO60-380**).

Item code
CO60-380

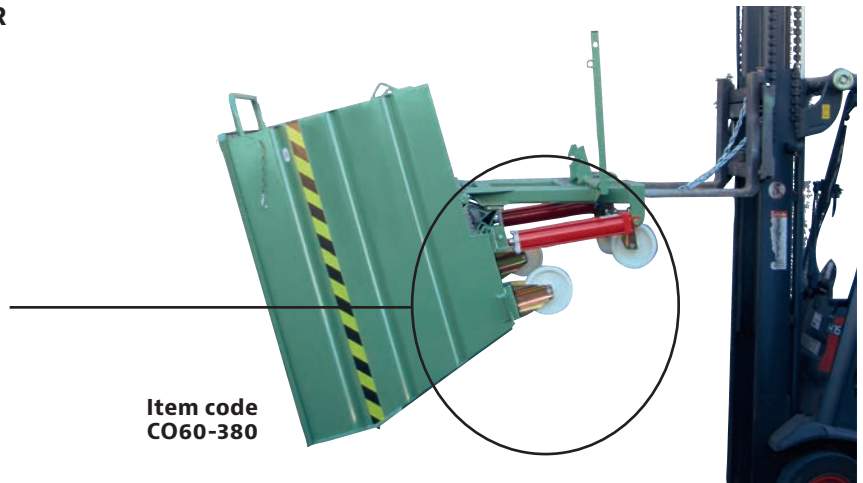

3 FIXED ADDITIONAL MESH SIDES FOR HANDLING BULKY MATERIALS

Fixed sides increase the capacity of the scrap container. When collecting bulky materials such as paper, cardboard, or boxes, the additional fixed sides provide the container with greater collection volume.

Available in mesh or sheet metal, with standard heights of 300 and 500 mm, or customised to your needs.



On request, all containers can be made of stainless steel or hot-dip galvanized.



Tipping scrap containers

Tipping scrap containers with manual release

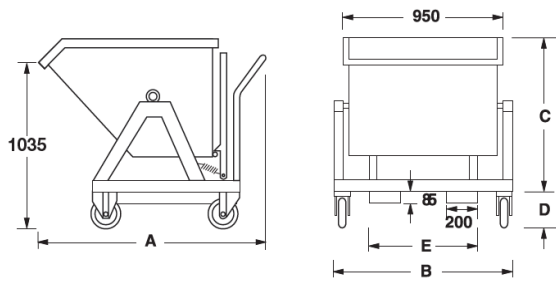

Item code
LT 0450

ITEM CODE	DIMENSIONS (mm)					Capacity (kg)	Volume (litres)
	A	B	C	D	E		
LT 0450	1190	1070	935	210	620	1000	400



Item code
LT 0460

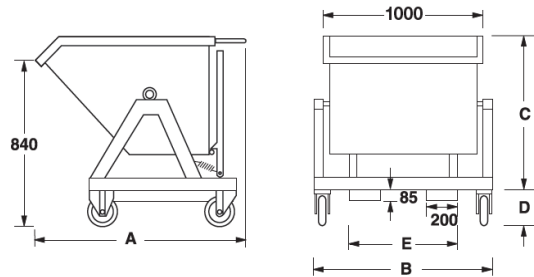

CE

Products that comply with EU requirements regarding safety, health, and environmental protection.

ITEM CODE	DIMENSIONS (mm)					Capacity (kg)	Volume (litres)
	A	B	C	D	E		
LT 0460	1175	1120	830	210	680	1000	438

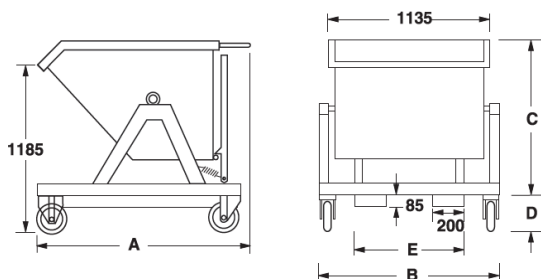

Item code
LT 0470

ITEM CODE	DIMENSIONS (mm)					Capacity (kg)	Volume (litres)
	A	B	C	D	E		
LT 0470	1205	1260	1075	210	815	1000	675



Tipping scrap containers

Tipping scrap containers with manual release

ACCESSORIES AVAILABLE UPON REQUEST:

1 HINGED LID, SPLIT IN HALF

2 REMOVABLE SHEET METAL LID WITH TWO HANDLES

3 RUBBER ANTI-VIBRATION PLUGS TO DAMPEN IMPACT DURING TIPPING

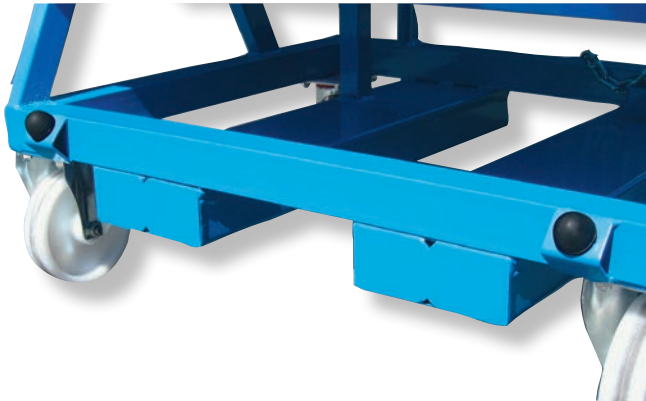

4 FORK LIFT BOXES WITH REINFORCEMENT COLLAR



5 SETTLING TANK WITH 4MM HOLE MESH GRID AND BALL VALVE FOR SEPARATING LIQUIDS FROM SOLIDS



Item code
VR

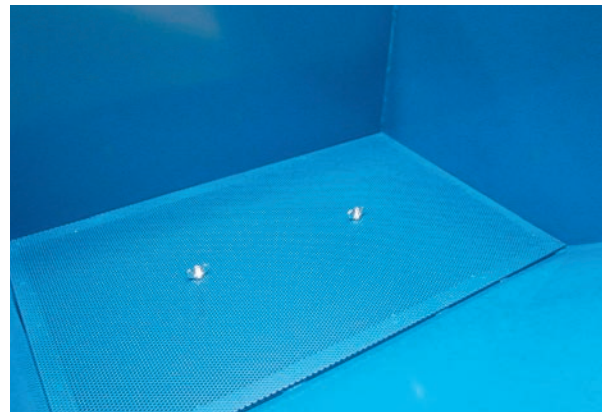

Tipping scrap containers

Tipping scrap containers with dynamic release

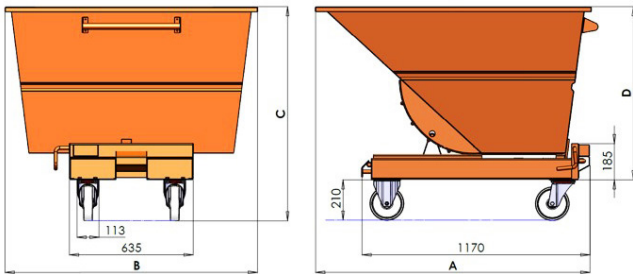
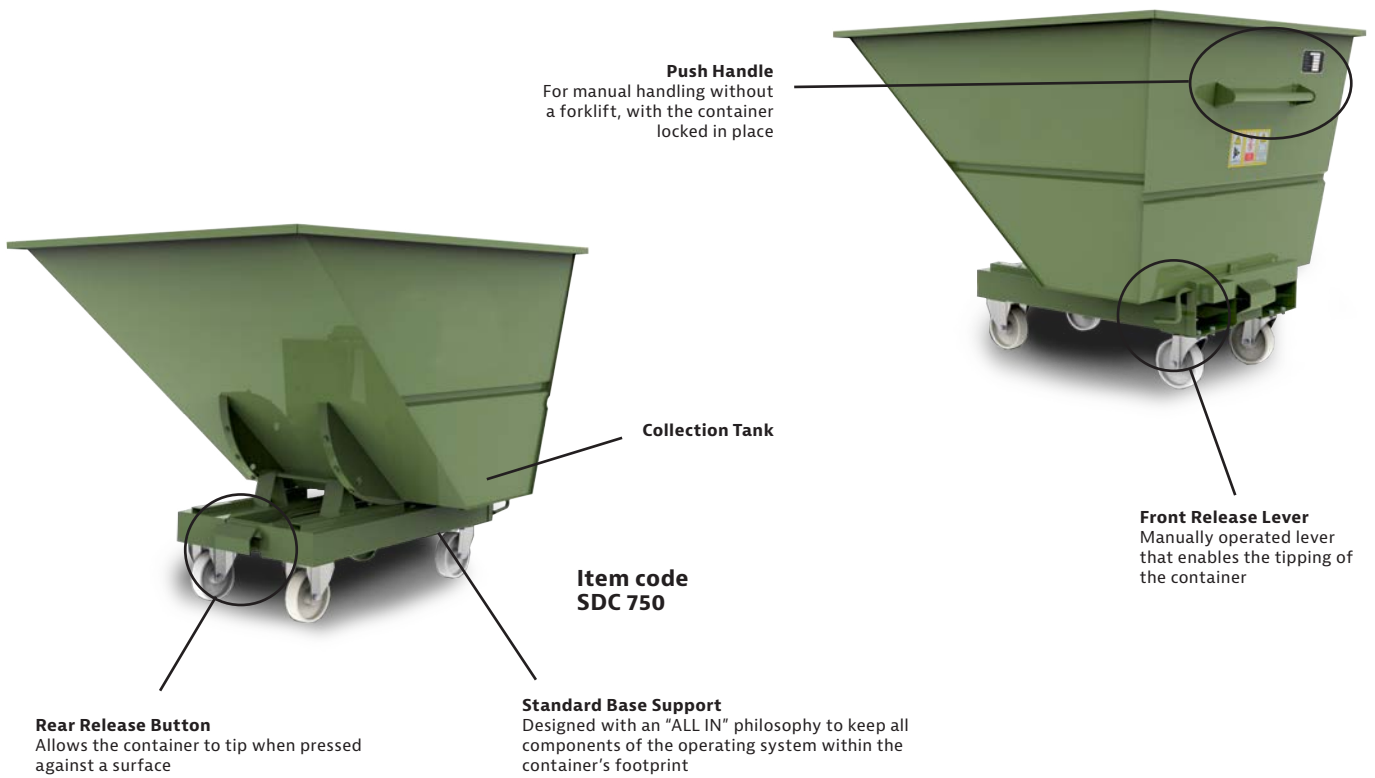

ITEM CODE	DIMENSIONS (mm)				Volume (litres)
	A	B	C	D	
SDC 550	1400	1000	1100	890	550
SDC 750	1400	1300	1100	890	750
SDC 1000	1570	1300	1250	1040	1000

Tipping scrap containers

Mesh tipping scrap containers



ITEM CODE	DIMENSIONS (mm)				Capacity (kg)	Volume (litres)
	A	B	C	D		
LTR 1350	1550	1320	1210	970	2000	1320
LTR 1600	1550	1550	1210	970	2000	1610
LTR 2000	1550	1950	1210	970	2000	2040

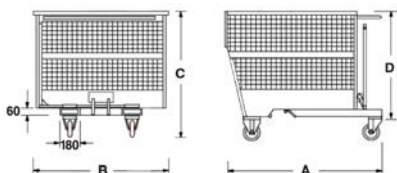

Products that comply with EU requirements regarding safety, health, and environmental protection.



Item code LTR 2000

Tipping scrap containers Tipping bins



ITEM CODE	DIMENSIONS (mm)			Capacity (kg)
	A	B	C	
SL 164 R	1420	1270	570	1000

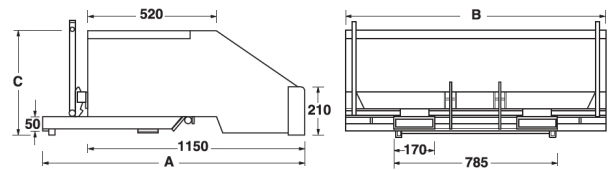

- Suitable for bulk materials of all types and snow
- Particularly robust structure
- Watertight tank
- Extremely manoeuvrable
- Equipped with anti-slip safety chain
- Tipping operated via rope from the forklift.

Item code
SL 164R



Products that comply with EU requirements regarding safety, health, and environmental protection.

Tipping scrap containers Tipping scrap containers for forklifts with rotating forks



Item code
SL 167 CR



ITEM CODE	DIMENSIONS (mm)				Capacity (kg)	Volume (litres)
	A	B	C	D		
SL 167 CR *	1130	1130	1010	240	1500	1145

* With wheels and lid.



- Ideal for the collection and disposal of all types of waste
- Emptying by tipping using forklift trucks with rotating forks.



ITEM CODE	DIMENSIONS (mm)				Capacity (kg)	Volume (litres)
	A	B	C	D		
SL 165P	1210	1100	1080	100	1500	1350
SL 165PCR *	1210	1100	1080	240	1500	1350

* With wheels.

Item code
SL 165P





TIPPING CONTAINERS & BOTTOM- OPENING CONTAINERS

b. ***Bottom- opening containers***

The best CE-certified solution for collecting, storing, transporting, and unloading materials, production waste, and industrial refuse efficiently and safely using a forklift.

Bottom-opening containers

Containers with a single opening bottom panel

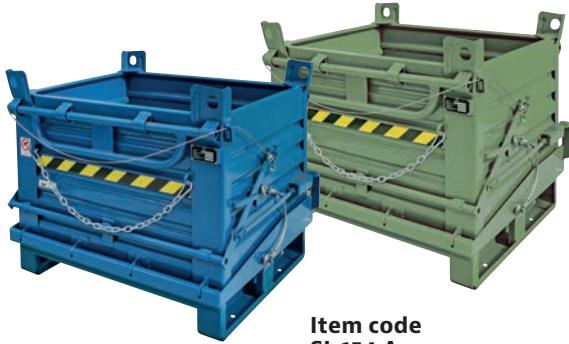

Item code
SL 154 A



Products that comply with EU requirements regarding safety, health, and environmental protection.

ITEM CODE	DIMENSIONS (mm)					Capacity (kg)
	A	B	C	D	E	
SL 154 A	1000	800	650	100	110	1300
SL 154 B	1200	1000	650	100	110	1400
SL 154 C	1500	1000	1000	100	110	1400

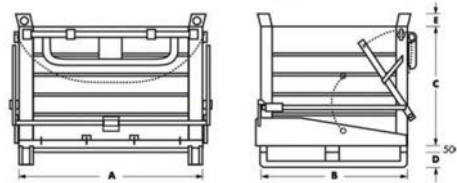

Item code
SL 150 BP

ITEM CODE	DIMENSIONS (mm)					Capacity (kg)
	A	B	C	D	E	
SL 150 AP	1200	800	800	130	110	1350
SL 150 BP	1200	1000	800	130	110	1350
SL 150 CP	1500	1000	800	130	110	1350

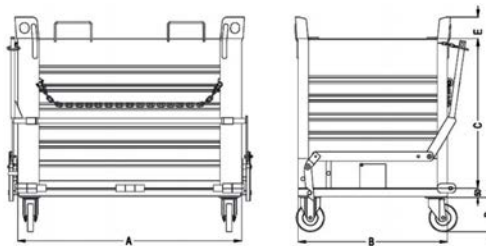

ITEM CODE	DIMENSIONS (mm)					Capacity (kg)
	A	B	C	D	E	
SL 150 AR	1200	800	800	184	110	1350
SL 150 BR	1200	1000	800	184	110	1350
SL 150 CR	1500	1000	800	184	110	1350



Item code
SL 150 BR



Bottom-opening containers

Containers with double opening bottom panels



Item code
SL 064 H1000

Item code
SL 064 H650



Item code
SL 064 H1300

ITEM CODE	DIMENSIONS (mm)					Capacity (kg)
	A	B	C	D	E	
SL 064 H650	1000	800	650	110	110	2000
SL 064 H1000	1000	800	1000	110	110	2000
SL 064 H1300	1000	800	1300	110	110	2000



Products that comply with EU requirements regarding safety, health, and environmental protection.



Item code
SL 153 A

Item code
SL 153 B



ITEM CODE	DIMENSIONS (mm)					Capacity (kg)
	A	B	C	D	E	
SL 153 A	1500	1000	650	110	110	2000
SL 153 B	2000	1000	1000	110	110	2000

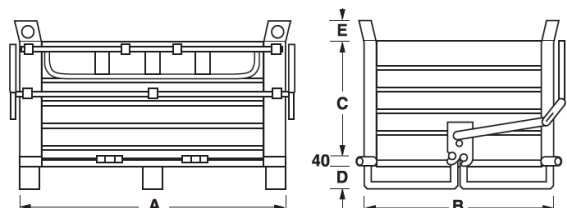



CONTAINERS FOR INDUSTRY

α. ***Sheet metal containers***

The Sall sheet metal containers allow for the most efficient handling and storage of large volumes of goods. They are available in a wide range of models, including airtight versions, with different shapes and sizes to meet any requirement.

Sheet metal containers

Steel sheet metal containers



Item code
MSL 26 F



On request:

- Welded cardholder
- Embossed or painted text, trademarks, and logos.

Sheet metal containers - With boxed foot (F)



Base (mm)	Usable height (mm)	Light series - Capacity 1200 kg	Medium series - Capacity 1700 kg	Heavy series - Capacity 2200 kg
800 x 600	400	MSL 14 F	MSM 14 F	MSH 14 F
800 x 600	500	MSL 15 F	MSM 15 F	MSH 15 F
1000 x 800	400	MSL 24 F	MSM 24 F	MSH 24 F
1000 x 800	500	MSL 25 F	MSM 25 F	MSH 25 F
1000 x 800	650	MSL 26 F	MSM 26 F	MSH 26 F
1000 x 800	800	MSL 28 F	MSM 28 F	MSH 28 F
1200 x 800	400	MSL 34 F	MSM 34 F	MSH 34 F
1200 x 800	500	MSL 35 F	MSM 35 F	MSH 35 F
1200 x 800	650	MSL 36 F	MSM 36 F	MSH 36 F
1200 x 800	800	MSL 38 F	MSM 38 F	MSH 38 F
1200 x 1000	400	MSL 44 F	MSM 44 F	MSH 44 F
1200 x 1000	500	MSL 45 F	MSM 45 F	MSH 45 F
1200 x 1000	650	MSL 46 F	MSM 46 F	MSH 46 F
1200 x 1000	800	MSL 48 F	MSM 48 F	MSH 48 F
1200 x 1000	1000	MSL 410 F	MSM 410 F	MSH 410 F
1500 x 800	400	MSL 54 F	MSM 54 F	MSH 54 F
1500 x 800	500	MSL 55 F	MSM 55 F	MSH 55 F
1500 x 800	650	MSL 56 F	MSM 56 F	MSH 56 F
1500 x 800	800	MSL 58 F	MSM 58 F	MSH 58 F
1500 x 800	1000	MSL 510 F	MSM 510 F	MSH 510 F
1500 x 1000	400	MSL 64 F	MSM 64 F	MSH 64 F
1500 x 1000	500	MSL 65 F	MSM 65 F	MSH 65 F
1500 x 1000	650	MSL 66 F	MSM 66 F	MSH 66 F
1500 x 1000	800	MSL 68 F	MSM 68 F	MSH 68 F
1500 x 1000	1000	MSL 610 F	MSM 610 F	MSH 610 F

Sheet metal containers

Steel sheet metal containers



Item code
MSL 25 SA



- On request:
- Welded cardholder
 - Embossed or painted text, trademarks, and logos.

Sheet metal containers - With long side skid (SA)



Base (mm)	Usable height (mm)	Light series - Capacity 1200 kg	Medium series - Capacity 1700 kg	Heavy series - Capacity 2200 kg
800 x 600	400	MSL 14 SA	MSM 14 SA	MSH 14 SA
800 x 600	500	MSL 15 SA	MSM 15 SA	MSH 15 SA
1000 x 800	400	MSL 24 SA	MSM 24 SA	MSH 24 SA
1000 x 800	500	MSL 25 SA	MSM 25 SA	MSH 25 SA
1000 x 800	650	MSL 26 SA	MSM 26 SA	MSH 26 SA
1000 x 800	800	MSL 28 SA	MSM 28 SA	MSH 28 SA
1200 x 800	400	MSL 34 SA	MSM 34 SA	MSH 34 SA
1200 x 800	500	MSL 35 SA	MSM 35 SA	MSH 35 SA
1200 x 800	650	MSL 36 SA	MSM 36 SA	MSH 36 SA
1200 x 800	800	MSL 38 SA	MSM 38 SA	MSH 38 SA
1200 x 1000	400	MSL 44 SA	MSM 44 SA	MSH 44 SA
1200 x 1000	500	MSL 45 SA	MSM 45 SA	MSH 45 SA
1200 x 1000	650	MSL 46 SA	MSM 46 SA	MSH 46 SA
1200 x 1000	800	MSL 48 SA	MSM 48 SA	MSH 48 SA
1200 x 1000	1000	MSL 410 SA	MSM 410 SA	MSH 410 SA
1500 x 800	400	MSL 54 SA	MSM 54 SA	MSH 54 SA
1500 x 800	500	MSL 55 SA	MSM 55 SA	MSH 55 SA
1500 x 800	650	MSL 56 SA	MSM 56 SA	MSH 56 SA
1500 x 800	800	MSL 58 SA	MSM 58 SA	MSH 58 SA
1500 x 800	1000	MSL 510 SA	MSM 510 SA	MSH 510 SA
1500 x 1000	400	MSL 64 SA	MSM 64 SA	MSH 64 SA
1500 x 1000	500	MSL 65 SA	MSM 65 SA	MSH 65 SA
1500 x 1000	650	MSL 66 SA	MSM 66 SA	MSH 66 SA
1500 x 1000	800	MSL 68 SA	MSM 68 SA	MSH 68 SA
1500 x 1000	1000	MSL 610 SA	MSM 610 SA	MSH 610 SA

Sheet metal containers

Steel sheet metal containers



Item code
MSL 26 FDA



On request:

- Welded cardholder
- Embossed or painted text, trademarks, and logos.

Sheet metal containers - With boxed foot (F) + long side door (DA)



Base (mm)	Usable height (mm)	Light series - Capacity 1200 kg	Medium series - Capacity 1700 kg	Heavy series - Capacity 2200 kg
800 x 600	400	MSL 14 FDA	MSM 14 FDA	MSH 14 FDA
800 x 600	500	MSL 15 FDA	MSM 15 FDA	MSH 15 FDA
1000 x 800	400	MSL 24 FDA	MSM 24 FDA	MSH 24 FDA
1000 x 800	500	MSL 25 FDA	MSM 25 FDA	MSH 25 FDA
1000 x 800	650	MSL 26 FDA	MSM 26 FDA	MSH 26 FDA
1000 x 800	800	MSL 28 FDA	MSM 28 FDA	MSH 28 FDA
1200 x 800	400	MSL 34 FDA	MSM 34 FDA	MSH 34 FDA
1200 x 800	500	MSL 35 FDA	MSM 35 FDA	MSH 35 FDA
1200 x 800	650	MSL 36 FDA	MSM 36 FDA	MSH 36 FDA
1200 x 800	800	MSL 38 FDA	MSM 38 FDA	MSH 38 FDA
1200 x 1000	400	MSL 44 FDA	MSM 44 FDA	MSH 44 FDA
1200 x 1000	500	MSL 45 FDA	MSM 45 FDA	MSH 45 FDA
1200 x 1000	650	MSL 46 FDA	MSM 46 FDA	MSH 46 FDA
1200 x 1000	800	MSL 48 FDA	MSM 48 FDA	MSH 48 FDA
1200 x 1000	1000	MSL 410 FDA	MSM 410 FDA	MSH 410 FDA
1500 x 800	400	MSL 54 FDA	MSM 54 FDA	MSH 54 FDA
1500 x 800	500	MSL 55 FDA	MSM 55 FDA	MSH 55 FDA
1500 x 800	650	MSL 56 FDA	MSM 56 FDA	MSH 56 FDA
1500 x 800	800	MSL 58 FDA	MSM 58 FDA	MSH 58 FDA
1500 x 800	1000	MSL 510 FDA	MSM 510 FDA	MSH 510 FDA
1500 x 1000	400	MSL 64 FDA	MSM 64 FDA	MSH 64 FDA
1500 x 1000	500	MSL 65 FDA	MSM 65 FDA	MSH 65 FDA
1500 x 1000	650	MSL 66 FDA	MSM 66 FDA	MSH 66 FDA
1500 x 1000	800	MSL 68 FDA	MSM 68 FDA	MSH 68 FDA
1500 x 1000	1000	MSL 610 FDA	MSM 610 FDA	MSH 610 FDA

Sheet metal containers

Steel sheet metal containers



Item code
MSL 26 SADA



- On request:
- Welded cardholder
 - Embossed or painted text, trademarks, and logos.

Sheet metal containers - With long side skid (SA) + long side door (DA)



Base (mm)	Usable height (mm)	Light series - Capacity 1200 kg	Medium series - Capacity 1700 kg	Heavy series - Capacity 2200 kg
800 x 600	400	MSL 14 SADA	MSM 14 SADA	MSH 14 SADA
800 x 600	500	MSL 15 SADA	MSM 15 SADA	MSH 15 SADA
1000 x 800	400	MSL 24 SADA	MSM 24 SADA	MSH 24 SADA
1000 x 800	500	MSL 25 SADA	MSM 25 SADA	MSH 25 SADA
1000 x 800	650	MSL 26 SADA	MSM 26 SADA	MSH 26 SADA
1000 x 800	800	MSL 28 SADA	MSM 28 SADA	MSH 28 SADA
1200 x 800	400	MSL 34 SADA	MSM 34 SADA	MSH 34 SADA
1200 x 800	500	MSL 35 SADA	MSM 35 SADA	MSH 35 SADA
1200 x 800	650	MSL 36 SADA	MSM 36 SADA	MSH 36 SADA
1200 x 800	800	MSL 38 SADA	MSM 38 SADA	MSH 38 SADA
1200 x 1000	400	MSL 44 SADA	MSM 44 SADA	MSH 44 SADA
1200 x 1000	500	MSL 45 SADA	MSM 45 SADA	MSH 45 SADA
1200 x 1000	650	MSL 46 SADA	MSM 46 SADA	MSH 46 SADA
1200 x 1000	800	MSL 48 SADA	MSM 48 SADA	MSH 48 SADA
1200 x 1000	1000	MSL 410 SADA	MSM 410 SADA	MSH 410 SADA
1500 x 800	400	MSL 54 SADA	MSM 54 SADA	MSH 54 SADA
1500 x 800	500	MSL 55 SADA	MSM 55 SADA	MSH 55 SADA
1500 x 800	650	MSL 56 SADA	MSM 56 SADA	MSH 56 SADA
1500 x 800	800	MSL 58 SADA	MSM 58 SADA	MSH 58 SADA
1500 x 800	1000	MSL 510 SADA	MSM 510 SADA	MSH 510 SADA
1500 x 1000	400	MSL 64 SADA	MSM 64 SADA	MSH 64 SADA
1500 x 1000	500	MSL 65 SADA	MSM 65 SADA	MSH 65 SADA
1500 x 1000	650	MSL 66 SADA	MSM 66 SADA	MSH 66 SADA
1500 x 1000	800	MSL 68 SADA	MSM 68 SADA	MSH 68 SADA
1500 x 1000	1000	MSL 610 SADA	MSM 610 SADA	MSH 610 SADA

Sheet metal containers

Sheet metal containers with flat bar skids

Flat skid on all sides

ITEM CODE	Width x Depth (mm)	Internal height (mm)	Capacity (kg)
SL407M	1100 x 725	600	1500
SL406M	1450 x 1100	600	1500
SL407P	1100 x 725	600	2000
SL406P	1450 x 1100	600	2000



Item code
SL407M

Sheet metal containers

Open-front containers



ITEM CODE	Width x Depth (mm)	Internal height (mm)	Capacity (kg)
SL018	1000 x 800	500	1000
SL083	1000 x 800	650	1000
SL084	1200 x 800	650	1000



ITEM CODE	Width x Depth (mm)	Internal height (mm)	Capacity (kg)
SL011	800 x 600	410	600



ITEM CODE	Width x Depth (mm)	Internal height (mm)	Capacity (kg)
SL130	800 x 500	500	1000



ITEM CODE	Width x Depth (mm)	Internal height (mm)	Capacity (kg)
SL201	630 x 450	230	500



Sheet metal containers

Foldable, stackable sheet metal containers



Item code
SL 159

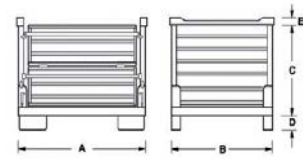

ITEM CODE	DIMENSIONS (mm)					Capacity (kg)
	A	B	C	D	E	
SL 159	1000	800	620	100	45	1000
SL 160	1200	800	620	100	45	1000
SL 161	1200	1000	820	100	45	1000
SL 162	1500	1000	970	100	45	1000



Sheet metal containers

Foldable sheet metal containers with lids

ITEM CODE	DIMENSIONS (mm)					Capacity (kg)
	A	B	C	D	E	
SLC 400	1200	800	410	120	65	1000
SLC 800	1200	800	795	120	65	1000

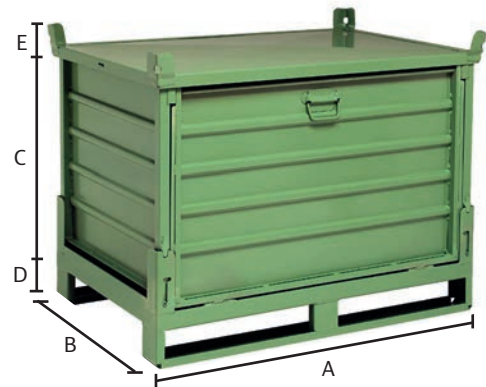

Item code
SLC 800



Stackable both open and closed and complete with: removable, lockable lid and grip handles on the long sides for easier opening and closing.

Five simple steps to close:





CONTAINERS FOR INDUSTRY

b. ***Mesh containers***

A complete range of mesh containers suitable for the handling and storage of various types of goods. All mesh containers are particularly useful when the contents need to be clearly visible. Each item is available in different sizes to meet various needs.

Mesh containers

Steel mesh containers



- On request:
- Welded cardholder
 - Embossed or painted text, trademarks, and logos.

Item code
WSL 28 F

Mesh containers - *With boxed foot (F)*



Base (mm)	Usable height (mm)	Light series - Capacity 1200 kg	Medium series - Capacity 1700 kg	Heavy series - Capacity 2200 kg
800 x 600	400	WSL 14 F	WSM 14 F	WSH 14 F
800 x 600	500	WSL 15 F	WSM 15 F	WSH 15 F
1000 x 800	400	WSL 24 F	WSM 24 F	WSH 24 F
1000 x 800	500	WSL 25 F	WSM 25 F	WSH 25 F
1000 x 800	650	WSL 26 F	WSM 26 F	WSH 26 F
1000 x 800	800	WSL 28 F	WSM 28 F	WSH 28 F
1200 x 800	400	WSL 34 F	WSM 34 F	WSH 34 F
1200 x 800	500	WSL 35 F	WSM 35 F	WSH 35 F
1200 x 800	650	WSL 36 F	WSM 36 F	WSH 36 F
1200 x 800	800	WSL 38 F	WSM 38 F	WSH 38 F
1200 x 1000	400	WSL 44 F	WSM 44 F	WSH 44 F
1200 x 1000	500	WSL 45 F	WSM 45 F	WSH 45 F
1200 x 1000	650	WSL 46 F	WSM 46 F	WSH 46 F
1200 x 1000	800	WSL 48 F	WSM 48 F	WSH 48 F
1200 x 1000	1000	WSL 410 F	WSM 410 F	WSH 410 F
1500 x 800	400	WSL 54 F	WSM 54 F	WSH 54 F
1500 x 800	500	WSL 55 F	WSM 55 F	WSH 55 F
1500 x 800	650	WSL 56 F	WSM 56 F	WSH 56 F
1500 x 800	800	WSL 58 F	WSM 58 F	WSH 58 F
1500 x 800	1000	WSL 510 F	WSM 510 F	WSH 510 F
1500 x 1000	400	WSL 64 F	WSM 64 F	WSH 64 F
1500 x 1000	500	WSL 65 F	WSM 65 F	WSH 65 F
1500 x 1000	650	WSL 66 F	WSM 66 F	WSH 66 F
1500 x 1000	800	WSL 68 F	WSM 68 F	WSH 68 F
1500 x 1000	1000	WSL 610 F	WSM 610 F	WSH 610 F

Mesh containers

Steel mesh containers



On request:

- Welded cardholder
- Embossed or painted text, trademarks, and logos.

Item code
WSL 28 SA

Mesh containers - With long side skid (SA)



Base (mm)	Usable height (mm)	Light series - Capacity 1200 kg	Medium series - Capacity 1700 kg	Heavy series - Capacity 2200 kg
800 x 600	400	WSL 14 SA	WSM 14 SA	WSH 14 SA
800 x 600	500	WSL 15 SA	WSM 15 SA	WSH 15 SA
1000 x 800	400	WSL 24 SA	WSM 24 SA	WSH 24 SA
1000 x 800	500	WSL 25 SA	WSM 25 SA	WSH 25 SA
1000 x 800	650	WSL 26 SA	WSM 26 SA	WSH 26 SA
1000 x 800	800	WSL 28 SA	WSM 28 SA	WSH 28 SA
1200 x 800	400	WSL 34 SA	WSM 34 SA	WSH 34 SA
1200 x 800	500	WSL 35 SA	WSM 35 SA	WSH 35 SA
1200 x 800	650	WSL 36 SA	WSM 36 SA	WSH 36 SA
1200 x 800	800	WSL 38 SA	WSM 38 SA	WSH 38 SA
1200 x 1000	400	WSL 44 SA	WSM 44 SA	WSH 44 SA
1200 x 1000	500	WSL 45 SA	WSM 45 SA	WSH 45 SA
1200 x 1000	650	WSL 46 SA	WSM 46 SA	WSH 46 SA
1200 x 1000	800	WSL 48 SA	WSM 48 SA	WSH 48 SA
1200 x 1000	1000	WSL 410 SA	WSM 410 SA	WSH 410 SA
1500 x 800	400	WSL 54 SA	WSM 54 SA	WSH 54 SA
1500 x 800	500	WSL 55 SA	WSM 55 SA	WSH 55 SA
1500 x 800	650	WSL 56 SA	WSM 56 SA	WSH 56 SA
1500 x 800	800	WSL 58 SA	WSM 58 SA	WSH 58 SA
1500 x 800	1000	WSL 510 SA	WSM 510 SA	WSH 510 SA
1500 x 1000	400	WSL 64 SA	WSM 64 SA	WSH 64 SA
1500 x 1000	500	WSL 65 SA	WSM 65 SA	WSH 65 SA
1500 x 1000	650	WSL 66 SA	WSM 66 SA	WSH 66 SA
1500 x 1000	800	WSL 68 SA	WSM 68 SA	WSH 68 SA
1500 x 1000	1000	WSL 610 SA	WSM 610 SA	WSH 610 SA

Mesh containers

Steel mesh containers



- On request:
- Welded cardholder
 - Embossed or painted text, trademarks, and logos.

Item code
WSL 28 FDA

Mesh containers - *With boxed foot (F) + long side door (DA)*



Base (mm)	Usable height (mm)	Light series - Capacity 1200 kg	Medium series - Capacity 1700 kg	Heavy series - Capacity 2200 kg
800 x 600	400	WSL 14 FDA	WSM 14 FDA	WSH 14 FDA
800 x 600	500	WSL 15 FDA	WSM 15 FDA	WSH 15 FDA
1000 x 800	400	WSL 24 FDA	WSM 24 FDA	WSH 24 FDA
1000 x 800	500	WSL 25 FDA	WSM 25 FDA	WSH 25 FDA
1000 x 800	650	WSL 26 FDA	WSM 26 FDA	WSH 26 FDA
1000 x 800	800	WSL 28 FDA	WSM 28 FDA	WSH 28 FDA
1200 x 800	400	WSL 34 FDA	WSM 34 FDA	WSH 34 FDA
1200 x 800	500	WSL 35 FDA	WSM 35 FDA	WSH 35 FDA
1200 x 800	650	WSL 36 FDA	WSM 36 FDA	WSH 36 FDA
1200 x 800	800	WSL 38 FDA	WSM 38 FDA	WSH 38 FDA
1200 x 1000	400	WSL 44 FDA	WSM 44 FDA	WSH 44 FDA
1200 x 1000	500	WSL 45 FDA	WSM 45 FDA	WSH 45 FDA
1200 x 1000	650	WSL 46 FDA	WSM 46 FDA	WSH 46 FDA
1200 x 1000	800	WSL 48 FDA	WSM 48 FDA	WSH 48 FDA
1200 x 1000	1000	WSL 410 FDA	WSM 410 FDA	WSH 410 FDA
1500 x 800	400	WSL 54 FDA	WSM 54 FDA	WSH 54 FDA
1500 x 800	500	WSL 55 FDA	WSM 55 FDA	WSH 55 FDA
1500 x 800	650	WSL 56 FDA	WSM 56 FDA	WSH 56 FDA
1500 x 800	800	WSL 58 FDA	WSM 58 FDA	WSH 58 FDA
1500 x 800	1000	WSL 510 FDA	WSM 510 FDA	WSH 510 FDA
1500 x 1000	400	WSL 64 FDA	WSM 64 FDA	WSH 64 FDA
1500 x 1000	500	WSL 65 FDA	WSM 65 FDA	WSH 65 FDA
1500 x 1000	650	WSL 66 FDA	WSM 66 FDA	WSH 66 FDA
1500 x 1000	800	WSL 68 FDA	WSM 68 FDA	WSH 68 FDA
1500 x 1000	1000	WSL 610 FDA	WSM 610 FDA	WSH 610 FDA

Mesh containers

Steel mesh containers



On request:

- Welded cardholder
- Embossed or painted text, trademarks, and logos.

Item code
WSL 28 SADA

Mesh containers - *With long side skid (SA) + long side door (DA)*



Base (mm)	Usable height (mm)	Light series - Capacity 1200 kg	Medium series - Capacity 1700 kg	Heavy series - Capacity 2200 kg
800 x 600	400	WSL 14 SADA	WSM 14 SADA	WSH 14 SADA
800 x 600	500	WSL 15 SADA	WSM 15 SADA	WSH 15 SADA
1000 x 800	400	WSL 24 SADA	WSM 24 SADA	WSH 24 SADA
1000 x 800	500	WSL 25 SADA	WSM 25 SADA	WSH 25 SADA
1000 x 800	650	WSL 26 SADA	WSM 26 SADA	WSH 26 SADA
1000 x 800	800	WSL 28 SADA	WSM 28 SADA	WSH 28 SADA
1200 x 800	400	WSL 34 SADA	WSM 34 SADA	WSH 34 SADA
1200 x 800	500	WSL 35 SADA	WSM 35 SADA	WSH 35 SADA
1200 x 800	650	WSL 36 SADA	WSM 36 SADA	WSH 36 SADA
1200 x 800	800	WSL 38 SADA	WSM 38 SADA	WSH 38 SADA
1200 x 1000	400	WSL 44 SADA	WSM 44 SADA	WSH 44 SADA
1200 x 1000	500	WSL 45 SADA	WSM 45 SADA	WSH 45 SADA
1200 x 1000	650	WSL 46 SADA	WSM 46 SADA	WSH 46 SADA
1200 x 1000	800	WSL 48 SADA	WSM 48 SADA	WSH 48 SADA
1200 x 1000	1000	WSL 410 SADA	WSM 410 SADA	WSH 410 SADA
1500 x 800	400	WSL 54 SADA	WSM 54 SADA	WSH 54 SADA
1500 x 800	500	WSL 55 SADA	WSM 55 SADA	WSH 55 SADA
1500 x 800	650	WSL 56 SADA	WSM 56 SADA	WSH 56 SADA
1500 x 800	800	WSL 58 SADA	WSM 58 SADA	WSH 58 SADA
1500 x 800	1000	WSL 510 SADA	WSM 510 SADA	WSH 510 SADA
1500 x 1000	400	WSL 64 SADA	WSM 64 SADA	WSH 64 SADA
1500 x 1000	500	WSL 65 SADA	WSM 65 SADA	WSH 65 SADA
1500 x 1000	650	WSL 66 SADA	WSM 66 SADA	WSH 66 SADA
1500 x 1000	800	WSL 68 SADA	WSM 68 SADA	WSH 68 SADA
1500 x 1000	1000	WSL 610 SADA	WSM 610 SADA	WSH 610 SADA

Mesh containers

Mesh containers with wheels



Item code
SR047 CR



ITEM CODE	Width x Depth (mm)	Internal height (mm)	Capacity (kg)
SR047 CR	1000 x 800	600	800
SR128 CR	1200 x 800	600	800
SR129 CR	1500 x 800	600	800

! Also available in the version with sheet metal walls.



Item code
SL047 CR

Frame with wheels for container handling



Item code
ST134

ITEM CODE	DIMENSIONS (mm)			Capacity (kg)
	A	B	C	
ST 134	830	530	240	800
ST 135	830	630	240	800
ST 136	1030	830	240	800
ST 137	1230	830	240	800
ST 138	1230	1030	240	800

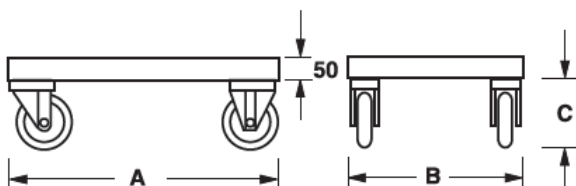

! Frame with wheels also available for sheet metal containers.

Mesh containers

Gitterbox model mesh containers



Item code
SR 12815

ITEM CODE	DIMENSIONS (mm)			Capacity (kg)
	Width	Depth	Height	
SR12815	1225	820	970	1000



Available on request with removable cardholder (item code PCLI/310210Z).

Mesh containers

Foldable, stackable mesh containers

ITEM CODE	DIMENSIONS (mm)					Capacity (kg)
	A	B	C	D	E	
SR 159	1000	800	620	100	45	1000
SR 160	1200	800	620	100	45	1000
SR 161	1200	1000	820	100	45	1000
SR 162	1500	1000	970	100	45	1000

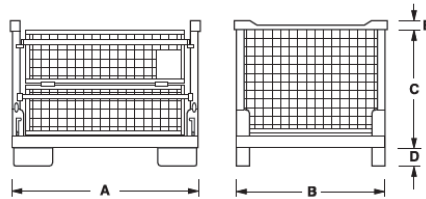

Item code
SR159



Mesh containers

Foldable mesh side panels



Item code
SR 156

ITEM CODE	DIMENSIONS (mm)					Capacity (kg)
	A	B	C	D	E	
SR 156	1215	815	800	100	40	1000

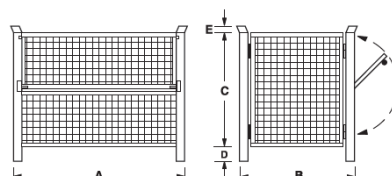

Mesh containers

Multifunctional containers

ITEM CODE	DIMENSIONS (mm)				Capacity (kg)
	A	B	C	D	
SR 163	1000	1000	1100	60	-



Complete with:

- Tech mesh side for operator protection, equipped with a gas cylinder to facilitate opening and closing, also simplifying product storage when not in use
- Automatically closing, anti-vibration access door, opening only inward and featuring a safety lock
- Non-slip and anti-static safety rubber floor
- Shock-resistant polystyrene tool tray
- Safety device to prevent accidental fork slippage
- Attachments for using seat belts (not included).



Available on request with wheels: 2 fixed and 2 swivel with brake (**item code SR 163 CR**).



METAL PALLET AND PLATFORMS

a. ***Open post pallets***

The open post pallets are high-capacity metal pallets that allow for handling with a forklift and vertical storage of bulky goods and materials in a warehouse. All stackable pallets feature a robust and durable steel structure with free-standing posts at the corners and are available in various versions.

Open post pallets

Open post pallets with feet



Item code
SP051



ITEM CODE	DIMENSIONS (mm)					Capacity (kg)
	A	B	C	D	E	
SP051	1000	800	580	120	40	1000
SP180	1000	800	800	120	40	1000
SP053	1200	800	580	120	40	1000
SP181	1200	800	800	120	40	1000
SP054	1200	1000	580	120	40	1000
SP182	1200	1000	800	120	40	1000
SP144	1500	800	580	120	40	1000

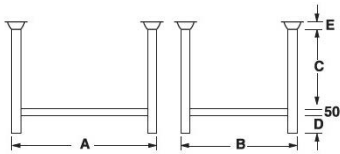

Open post pallets

Open post pallets with skids



ITEM CODE	DIMENSIONS (mm)					Capacity (kg)
	A	B	C	D	E	
SP050	1000	800	600	120	60	1500
SP184	1000	800	800	150	60	1500
SP141	1200	800	600	150	60	1500
SP185	1200	800	800	150	60	1500
SP142	1200	1000	600	150	60	1500
SP186	1200	1000	800	150	60	1500
SP143	1500	800	600	150	60	1500
SP183	1500	1000	600	150	60	1500

Available on request with a foot with a cup at the base.

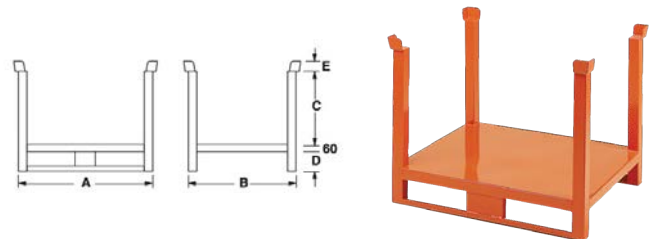

Item code
SP050

ITEM CODE	DIMENSIONS (mm)					Capacity (kg)
	A	B	C	D	E	
SP049	1000	800	610	150	110	1500
SP139	1200	800	610	150	110	1500
SP140	1200	1000	610	150	110	1500

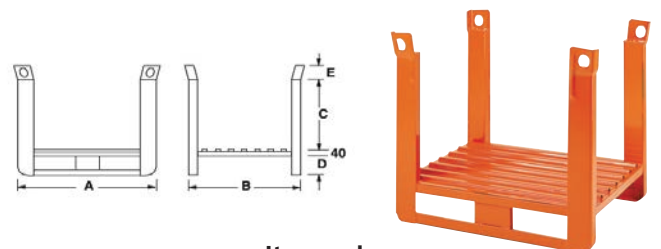

Item code
SP049

ITEM CODE	DIMENSIONS (mm)					Capacity (kg)
	A	B	C	D	E	
SP211	1000	800	610	110	90	2000
SP212	1200	800	610	110	90	2000
SP213	1200	1000	610	110	90	2000
SP214	1500	800	610	110	90	2000
SP215	1500	1000	610	110	90	2000

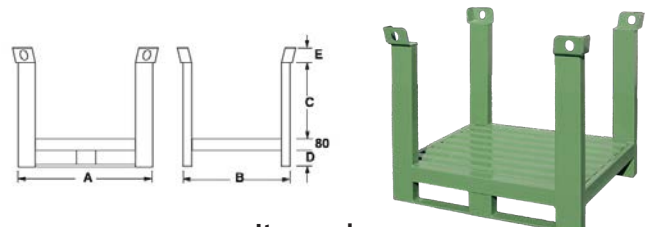

Item code
SP211

Open post pallets

Open post pallets with removable wooden deck



Item code
SP052



ITEM CODE	DIMENSIONS (mm)					Capacity (kg)
	A	B	C	D	E	
SP052	1000	800	565	120	40	1000
SP145	1200	800	565	120	40	1000
SP146	1200	1000	565	120	40	1000
SP147	1500	800	565	120	40	1000

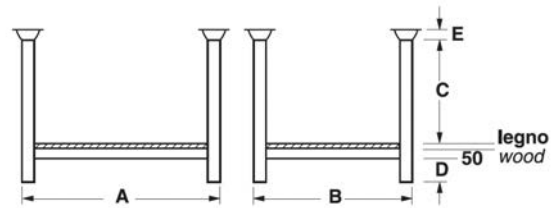

Open post pallets

Pallets with detachable posts



ITEM CODE	DIMENSIONS (mm)			Capacity (kg)
	A	B	C	
SP 11493	1500	790	1100	1000

Item code
SP 11493

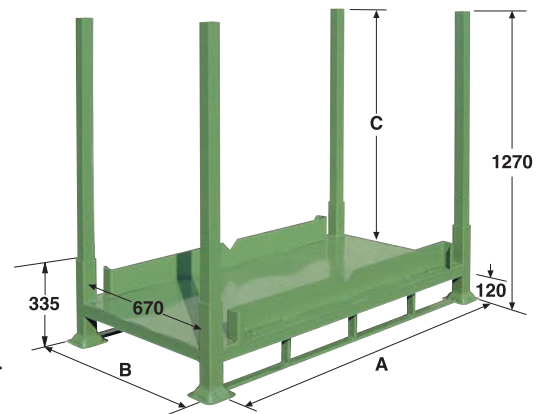

A particularly versatile pallet. The uprights are easily removable by hand from their slots. Once removed and placed in the designated compartments, they help optimize space during storage and transportation.

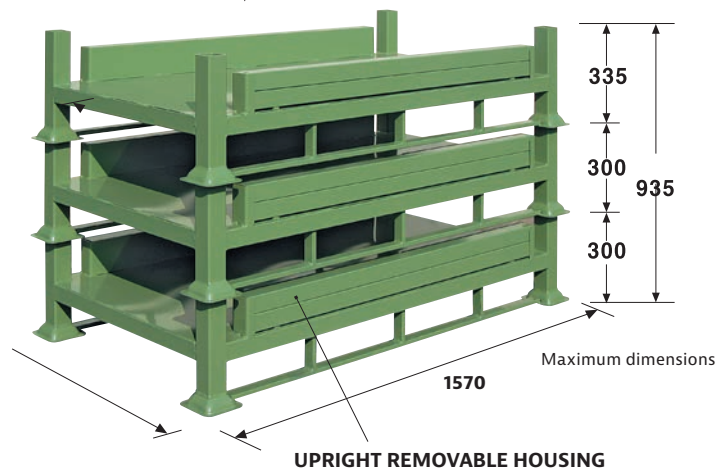



Certified models for being:

- Lifiable with crane or overhead crane
- Customisable with sheet metal base, wheels (excluding **item code SP6000**) and fork lift brackets
- Ability to close the internal sides with sheet metal or mesh walls and/or crossbars for storing small tubes/bars
- Stackable 1 + 2.

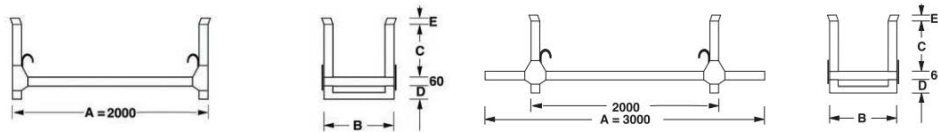

ITEM CODE	DIMENSIONS (mm)					Capacity (kg)
	A	B	C	D	E	
SP055	2000	560	500	100	60	2000
SP056	3000	560	500	100	60	3000

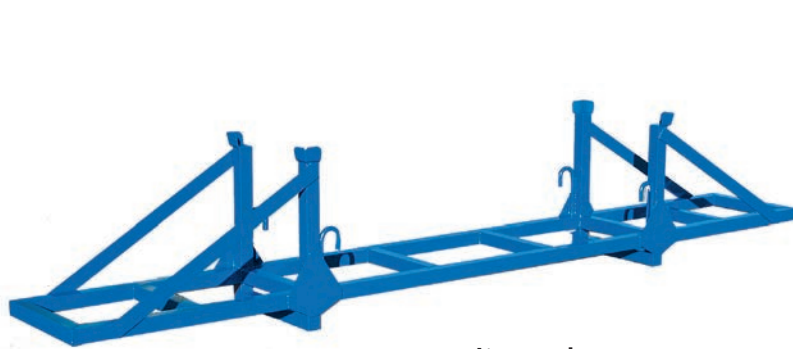

Item code
SP056L

Item code
SP6000

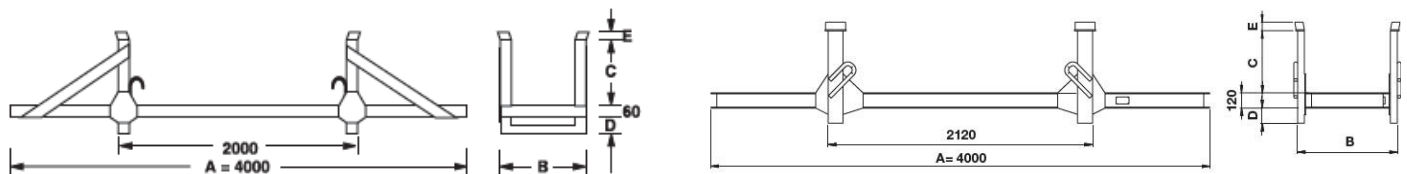
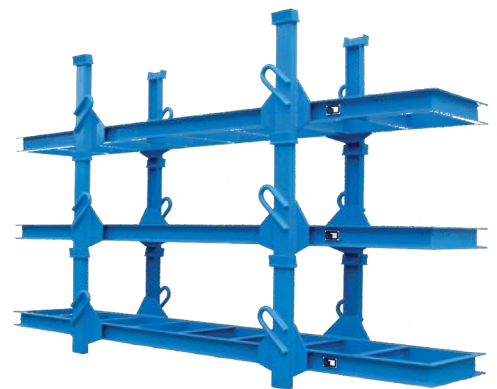

ITEM CODE	DIMENSIONS (mm)					Capacity (kg)
	A	B	C	D	E	
SP056L	4000	560	500	100	60	3000
SP6000	4000	800	490	120	70	6000

Open post pallets

Foldable, stackable pallets



ITEM CODE	DIMENSIONS (mm)							Capacity (kg)
	A	B	C	D	E	F	G	
SP 157	1200	800	800	150	50	1290	890	800
SP 158	1200	1000	800	150	50	1290	1090	800

Item code
SP 157

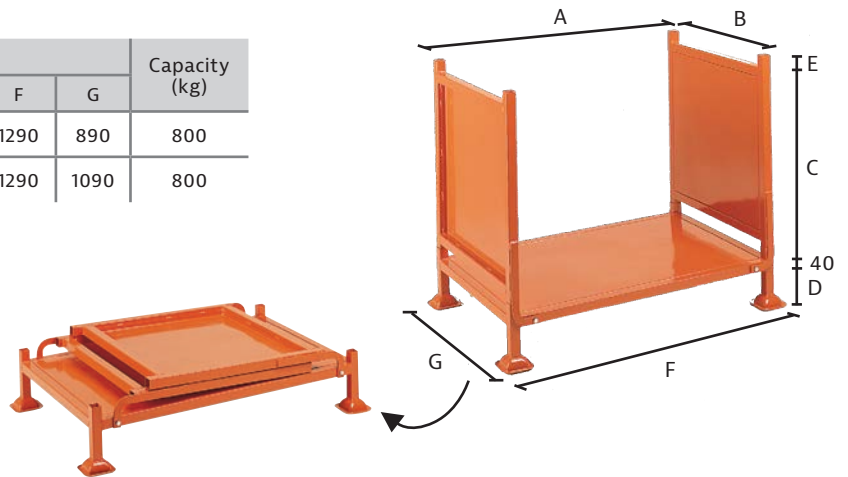

Open post pallets

Sides for wooden pallets



Item code
SPAB215



ITEM CODE	DIMENSIONS (mm)			Capacity (kg)
	Larg.	Prof.	Alt.	
SPAB215	1208	808	980	1000

* For Europallet.

Open post pallets

Fabric storage pallets



ITEM CODE	DIMENSIONS (mm)					Capacity (kg)
	A	B	C	D	E	
SP149	1500	800	800	120	60	1000
SP151	1500	1000	800	120	60	1000



• Stackable.

Item code
SP149

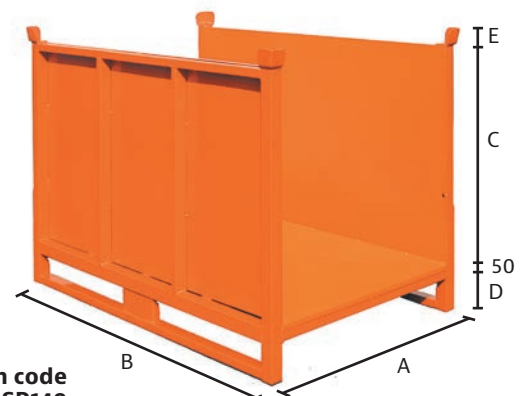



METAL PALLETES AND PLATFORMS

b. ***Metal platforms***

Ideal for the transportation, handling, and storage of heavy goods and materials in a warehouse, Sall platforms are made of carbon steel and are available in galvanized or powder-coated finishes. They are perfect for heavy loads, logistics, and sectors that require high strength, durability, and capacity.

Metal platforms

Metal platforms with 2 skids



Item code
SPN060
(cross braces)

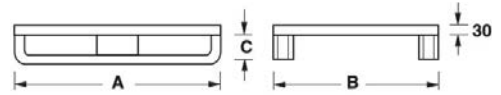

ITEM CODE	DIMENSIONS (mm)			Capacity (kg)
	A	B	C	
SPN060	1000	800	120	1000
SPN062	1200	800	120	1000
SPN068	1200	1000	120	1000

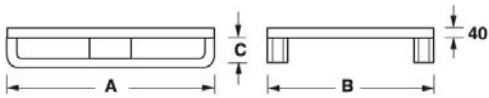

ITEM CODE	DIMENSIONS (mm)			Capacity (kg)
	A	B	C	
SP060	1000	800	120	1500
SP062	1200	800	120	1500
SP068	1200	1000	120	1500



Item code
SP060
(longitudinal braces)



Item code
SP070
(sheet metal bottom + wooden top)

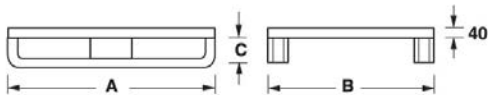

ITEM CODE	DIMENSIONS (mm)			Capacity (kg)
	A	B	C	
SPN070	1000	800	120	1000
SPN071	1200	800	120	1000
SPN072	1200	1000	120	1000



ITEM CODE	DIMENSIONS (mm)			Capacity (kg)
	A	B	C	
SP070	1000	800	120	1500
SP071	1200	800	120	1500
SP072	1200	1000	120	1500



Item code
SPN070
(sheet metal bottom + wooden top)

Metal platforms

Metal platforms with 3 skids



Item code
SPN061
(cross braces)

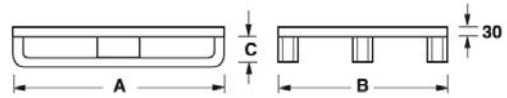

ITEM CODE	DIMENSIONS (mm)			Capacity (kg)
	A	B	C	
SPN061	1000	800	120	1500
SPN063	1200	800	120	1500
SPN069	1200	1000	120	1500

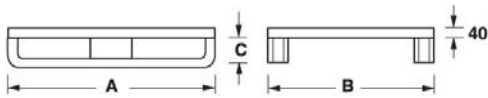

Item code
SP061
(longitudinal braces)

ITEM CODE	DIMENSIONS (mm)			Capacity (kg)
	A	B	C	
SP061	1000	800	120	2000
SP063	1200	800	120	2000
SP069	1200	1000	120	2000

Metal platforms

Reversible double-bottom metal platforms



Item code
SP073

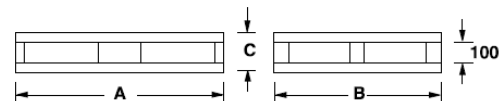

ITEM CODE	DIMENSIONS (mm)			Capacity (kg)
	A	B	C	
SP 073	1000	800	180	2000
SP 074	1200	800	180	2000
SP 075	1200	1000	180	2000



IMPORTANT

The pallets must always be handled one at a time. They are specifically designed to be lifted and moved with a pallet jack or forklift; always perform lifting movements with the forks tilted towards the operator.

CABINETS AND STORAGE UNITS FOR GAS CYLINDERS

***α.* Boxes and storage units for gas cylinders**

The extensive Sall range offers cylinder storage units and boxes configured as cages and modular storage units equipped with anti-intrusion locks, designed to ensure compliant and secure storage of up to 36 cylinders. All models are customizable in terms of size and accessories. For specific requirements, made-to-measure cylinder storage units can be created.



Boxes and storage units for gas cylinders

Safety storage units for compressed gas cylinders



Item code
PANDESA 3

ITEM CODE	External dimensions W x D x H (mm)	Cylinder capacity	Load capacity (kg)
PANDESA 3	960 x 880 x 2400	3 gas cylinders	262
PANDESA 6	1760 x 880 x 2400	6 gas cylinders	377
PANDESA 6+ 3	2640 x 880 x 2400	9 gas cylinders	568
PANDESA 10	1760 x 1680 x 2400	10 gas cylinders	550



Certified by the Ministry of the Interior, Cert. no. 3804/30/91.



Item code
PANDESA 3

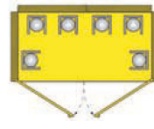

Item code
PANDESA 6

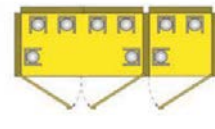

Item code
PANDESA 6 + 3

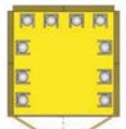

Item code
PANDESA 10



Item code
PBO 15 SB Z

Item code
PBO 15 CB Z

Ramp available upon
request
(item code
RAPBO 15 Z)

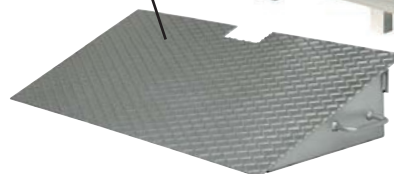

ITEM CODE	External dimensions W x D x H (mm)	Cylinder capacity
PBO 15 SB Z Without base	1550 x 1210 x 2285	1 pallet + 4 gas cylinders or 2 compartments, each with 3 rows of 4 gas cylinders
PBO 15 CB Z With base	1550 x 1210 x 2450	1 pallet + 4 gas cylinders or 2 compartments, each with 3 rows of 4 gas cylinders
PBO 30 SB Z Without base	3180 x 1600 x 2285	2 pallets + 8 gas cylinders or 4 compartments, each with 3 rows of 4 gas cylinders
PBO 30 CB Z With base	3180 x 1600 x 2450	2 pallets + 8 gas cylinders or 4 compartments, each with 3 rows of 4 gas cylinders

Boxes and storage units for gas cylinders

Safety storage units for compressed gas cylinders



Item code
PBO 11 CBZ

Ramp available upon request
(item code
RAPBO 11 CBZ)

Removable shelf available upon request for storing small-sized cylinders
(item code
PBO 11 CBZ/1R)

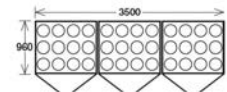
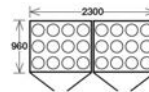

ITEM CODE	PBO 11 CBZ	PBO 23 CBZ	PBO 35 CBZ
Number of 50L cylinders, diameter 230 mm	12	24	36
Width x Depth x Height (mm)	960 x 1130 x 2100	960 x 2300 x 2100	960 x 3500 x 2100

Boxes and storage units for gas cylinders

Safety cabinets for compressed gas cylinders



Safety cabinets for the storage of compressed gas cylinders with fire resistance class G for 30 minutes, certified according to EN 14470-2, EN 16121, REPORT LAPI no. 771.0, EN 0150/13.

Customisable with:

- Spark-proof extractor in a metal box (item code **DIAM 125 BP**)
- Activated carbon filter (item code **R SOL**)
- Internal or external automatic fire extinguisher (item code **ESTINTORE**).

Item code
B 120 G30



Item code
B 60 G30



ITEM CODE	External dimensions W x D x H (mm)	Door	Cylinder capacity
B60 G30	590 x 600 x 2050	Single door	1/2
B120 G30	1190 x 600 x 2050	Double door	3/4



CABINETS AND STORAGE UNITS FOR GAS CYLINDERS

b. ***Pallets for transporting gas cylinders***

The gas cylinder baskets produced by Sall are specific pallets for the storage and transportation of gas cylinders, designed to be safely handled by both forklifts and cranes. Made with a robust hot-dip galvanized steel structure, they are equipped with a fastening bracket and a safety device to prevent accidental falls of gas cylinders during transport, thereby maximizing safety levels.

Pallets for transporting gas cylinders

Pallets for transporting compressed gas cylinders



Item code
PBO 04Z



Item code
PBO 08Z

Item code
PBO 12Z

ITEM CODE	Number of cylinders Ø 230 mm	External dimensions W x D x H (mm)
PBO 04Z	4	860 x 650 x 1115
PBO 08Z	8	860 x 1170 x 1115
PBO 012Z	12	1030 x 805 x 1225



Equipped with an automatic closing safety device.
In the **PBO12Z model** the access ramp, once closed, becomes a protective side..

Pallets for transporting gas cylinders

Trolleys and supports for compressed gas cylinders

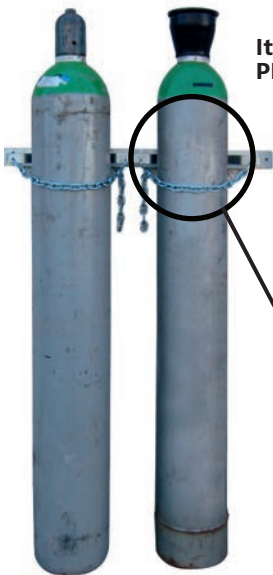

Item code
PBP 02 Z



Wall support for
2 cylinders



Item code
CABO 12 RZ

Item code
CABO 23 RZ

Steel trolleys for cylinders



ITEM CODE	Number of cylinders Ø 250 mm	External dimensions W x D x H (mm)
PBP 02 Z	2	860 x 60 x 115
CABO 23 RZ	2	780 x 770 x 1290
CABO 12 RZ	1	490 x 460 x 1260

CONTAINERS FOR WASTE COLLECTION

a. **Big bag holders**

The Sall big bag holders ensure maximum safety during the filling, handling, and storage of big bags containing both industrial materials and hazardous substances or waste, such as in the case of big bag sacks. The stackable design and dismantable structure allow for optimized storage space as well as minimized bulk and transport cost.



Big bag holders

Big bag holder pallets

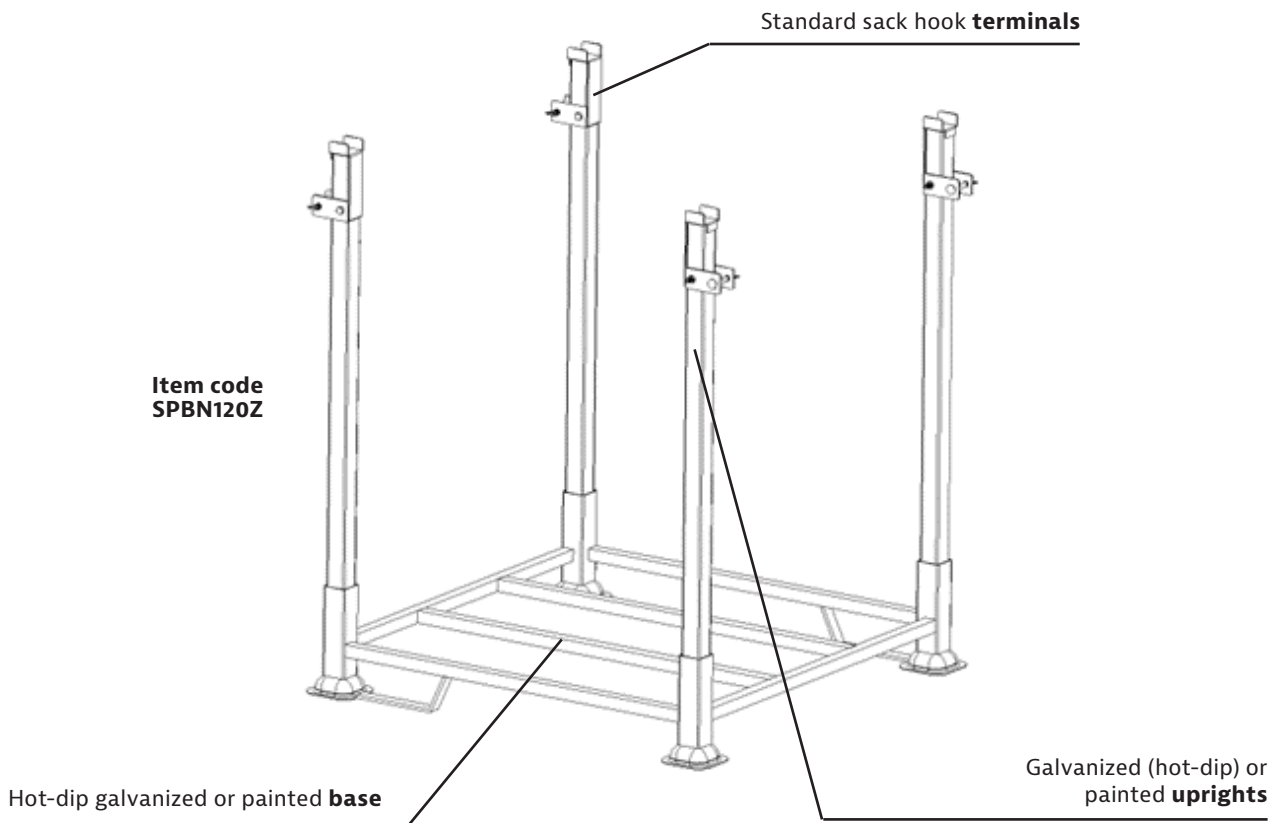

Standard configuration



ITEM CODE	Description	W x D x H (mm)	Capacity (kg)
SPBN 120 Z	Standard configuration: 4 standard sack hook terminals + 1 hot-dip galvanized or painted base + 4 galvanized (hot-dip) or painted uprights	1080 x 1080 x 1347	1000



- 1. EASY TO HANDLE**
- 2. CONFIGURABLE** thanks to a wide range of available accessories (see next page)
- 3. SUITABLE FOR BOTH INDOOR AND OUTDOOR USE** due to the two available base versions (hot-dip galvanized and/or powder-coated).



Accessories

ITEM CODE	Description
PALN120	Steel support plate
INSPLUS120	Plus insert with 3 sack attachment positions
SPON120	Single side panel
INSCAPN120	Sack hook terminal with cap
ALLN120	Removable upright extension 220 mm
PARN120	Mesh plate
CRMN120	Transport trolley
COPN120	Removable galvanized steel lid
VASN120	Movable basin

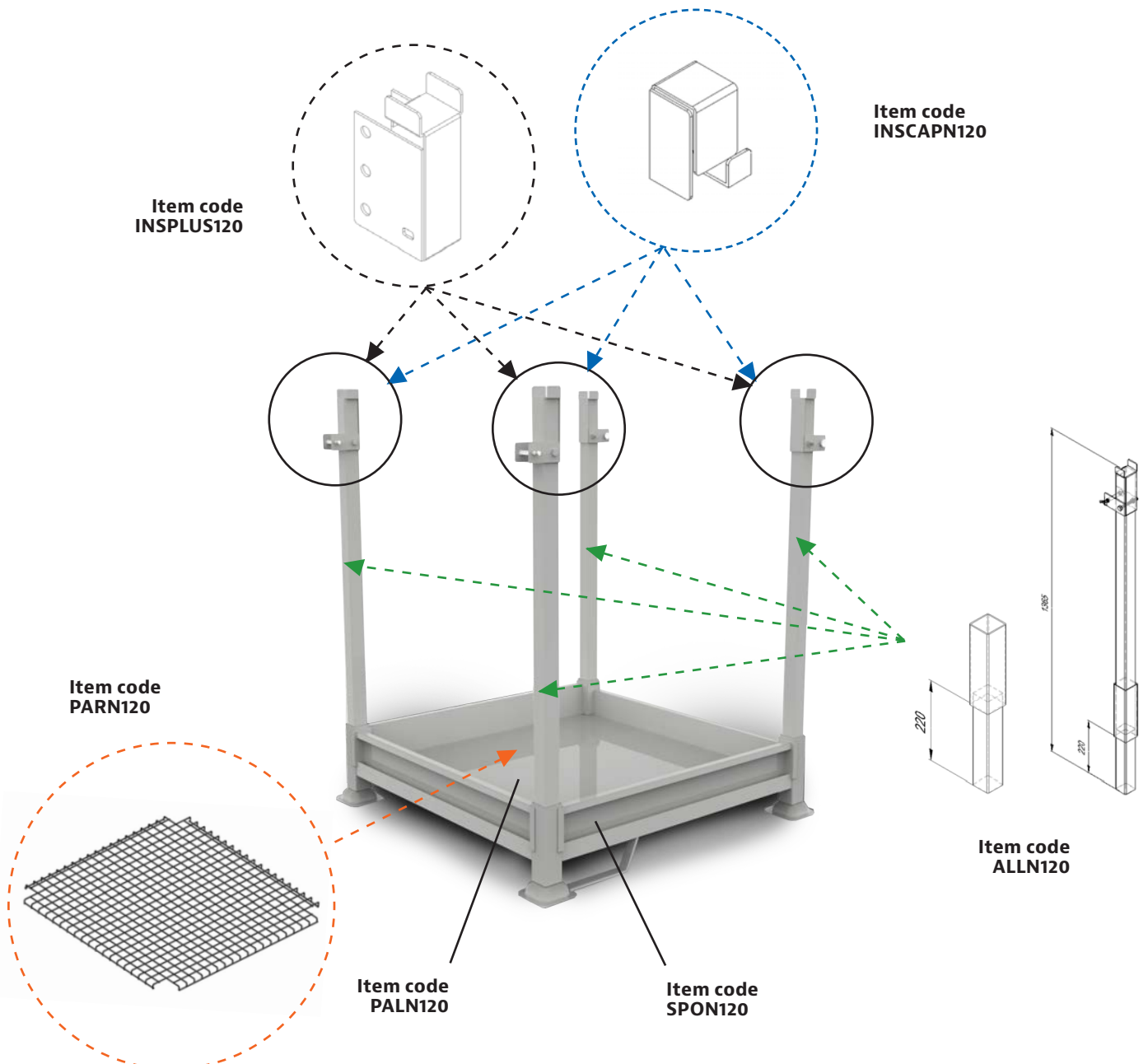

Big bag holders

Big bag holder pallets

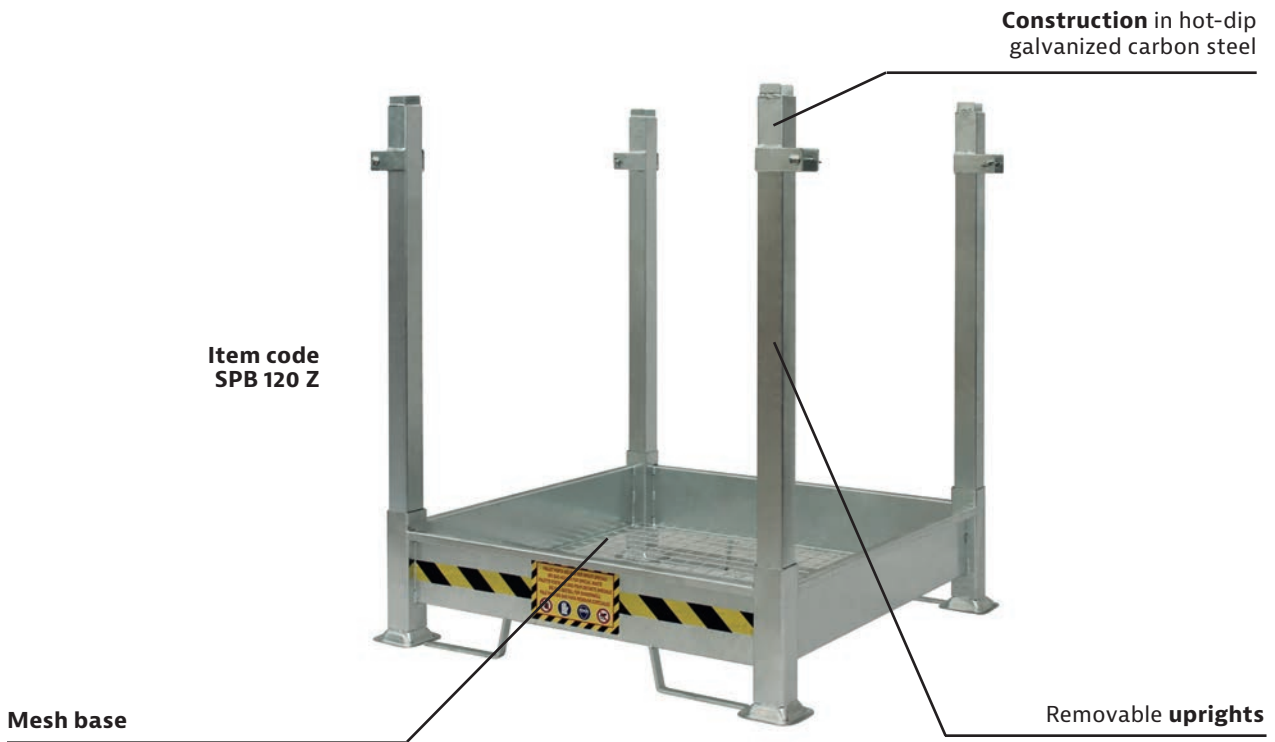

Standard configuration



ITEM CODE	W x D x H (mm)	Capacity (kg)
SPB 120 Z	1070 x 1070 x 1350	1000

Accessories

ITEM CODE	W x D x H (mm)	Capacity (kg)	Volume (litres)
BBAG 1000 ONU	900 x 900 x 1200	1000	1000



Available upon request:

1. Removable lid with handles
2. ONU 3/Y certified **big bag** with a capacity of 1000 kg (certification "R" on a yellow bottom as per D.L. 52 of 03/02/1997, complete with internal liner).



Big bag holders

Big bag holders with collection tray



- Carbon steel structure
- Removable uprights
- External corrosion-resistant treatment
- Available upon request in a painted version
- Also available upon request with wheels: 2 fixed and 2 swivel with brakes (**item code SPB122CR**).



**Item code
SPB122Z**



**Item code
SPB122CR**



ITEM CODE	W x D x H (mm)	Capacity (kg)	Volume (litres)
SPB122A	1000 x 1000 x 1860	1000	208
SPB122Z	1000 x 1000 x 1860	1000	208
SPB122CRA	1000 x 1000 x 1998	900	208
SPB122CRZ	1000 x 1000 x 1998	900	208

Big bag holders

Big bag holders with lid



Gas pistons
to assist the
opening of the
hinged upper door

**Item code
SPB121**



ITEM CODE	External dimensions W x D x H (mm)	Capacity (kg)
SPB121	1100 x 1100 x 1360	1000



- Ideal for temporary storage of waste
- Made with a square-shaped base, supporting casing in carbon steel
- Labeling and safety symbols available upon request for product identification.

PRODUCT INDEX

A			
ALLN120	p. 47		
B			
B120G30	p. 42		
B60G30	p. 42		
BBAG1000ONU	p. 48		
C			
CABO12RZ	p. 44		
CABO23RZ	p. 44		
CO60-380	p. 9		
COPN120	p. 47		
CRMN120	p. 47		
D			
DIAM125BP	p. 42		
E			
ESTINTORE	p. 42		
I			
INSCAPN120	p. 47		
INSPLUS120	p. 47		
L			
LT0280	p. 8		
LT0300	p. 8		
LT0450	p. 10		
LT0460	p. 10		
LT0470	p. 10		
LT0500	p. 8		
LT0750	p. 8		
LT1000	p. 8		
LT1350	p. 8		
LT1600	p. 8		
LT2000	p. 8		
LTR1350	p. 12		
LTR1600	p. 12		
LTR2000	p. 12		
M			
MSH 14	pp. 18-19-20-21	MSH 35	pp. 18-19-20-21
MSH 15	pp. 18-19-20-21	MSH 36	pp. 18-19-20-21
MSH 24	pp. 18-19-20-21	MSH 38	pp. 18-19-20-21
MSH 25	pp. 18-19-20-21	MSH 410	pp. 18-19-20-21
MSH 26	pp. 18-19-20-21	MSH 44	pp. 18-19-20-21
MSH 28	pp. 18-19-20-21	MSH 45	pp. 18-19-20-21
MSH 34	pp. 18-19-20-21	MSH 46	pp. 18-19-20-21
		MSH 48	pp. 18-19-20-21
		MSH 510	pp. 18-19-20-21
		MSH 54	pp. 18-19-20-21
		MSH 55	pp. 18-19-20-21
		MSH 56	pp. 18-19-20-21
		MSH 58	pp. 18-19-20-21
		MSH 610	pp. 18-19-20-21
		MSH 64	pp. 18-19-20-21
		MSH 65	pp. 18-19-20-21
		MSH 66	pp. 18-19-20-21
		MSH 68	pp. 18-19-20-21
		MSL 14	pp. 18-19-20-21
		MSL 15	pp. 18-19-20-21
		MSL 24	pp. 18-19-20-21
		MSL 25	pp. 18-19-20-21
		MSL 26	pp. 18-19-20-21
		MSL 28	pp. 18-19-20-21
		MSL 34	pp. 18-19-20-21
		MSL 35	pp. 18-19-20-21
		MSL 36	pp. 18-19-20-21
		MSL 38	pp. 18-19-20-21
		MSL 410	pp. 18-19-20-21
		MSL 44	pp. 18-19-20-21
		MSL 45	pp. 18-19-20-21
		MSL 46	pp. 18-19-20-21
		MSL 48	pp. 18-19-20-21
		MSL 510	pp. 18-19-20-21
		MSL 54	pp. 18-19-20-21
		MSL 55	pp. 18-19-20-21
		MSL 56	pp. 18-19-20-21
		MSL 58	pp. 18-19-20-21
		MSL 610	pp. 18-19-20-21
		MSL 64	pp. 18-19-20-21
		MSL 65	pp. 18-19-20-21
		MSL 66	pp. 18-19-20-21
		MSL 68	pp. 18-19-20-21
		MSM 14	pp. 18-19-20-21
		MSM 15	pp. 18-19-20-21
		MSM 24	pp. 18-19-20-21
		MSM 25	pp. 18-19-20-21
		MSM 26	pp. 18-19-20-21
		MSM 28	pp. 18-19-20-21
		MSM 34	pp. 18-19-20-21
		MSM 35	pp. 18-19-20-21
		MSM 36	pp. 18-19-20-21
		MSM 38	pp. 18-19-20-21
		MSM 410	pp. 18-19-20-21
		MSM 44	pp. 18-19-20-21
		MSM 45	pp. 18-19-20-21
		MSM 46	pp. 18-19-20-21
		MSM 48	pp. 18-19-20-21
		MSM 510	pp. 18-19-20-21
		MSM 54	pp. 18-19-20-21
		MSM 55	pp. 18-19-20-21
		MSM 56	pp. 18-19-20-21
		MSM 58	pp. 18-19-20-21
		MSM 610	pp. 18-19-20-21
		MSM 64	pp. 18-19-20-21
		MSM 65	pp. 18-19-20-21
		MSM 66	pp. 18-19-20-21
		MSM 68	pp. 18-19-20-21
		P	
		PALN120	p. 47
		PANDESA10	p. 41
		PANDESA3	p. 41
		PANDESA6	p. 41
		PANDESA6+3	p. 41
		PARN120	p. 47
		PBO011CBZ	p. 42
		PBO011CBZ/1R	p. 42
		PBO04Z	p. 44
		PBO08Z	p. 44
		PBO12Z	p. 44
		PBO15CBZ	p. 41
		PBO15SBZ	p. 41
		PBO23CBZ	p. 42
		PBO30CBZ	p. 41
		PBO30SBZ	p. 41
		PBO35CBZ	p. 42
		PBP02Z	p. 44
		PCLI/310210Z	p. 30
		R	
		RSOL	p. 42
		S	
		SDC1000	p. 12
		SDC550	p. 12
		SDC750	p. 12
		SL011	p. 22
		SL018	p. 22
		SL047CR	p. 29
		SL064H1000	p. 16
		SL064H1300	p. 16
		SL064H650	p. 16
		SL083	p. 22
		SL084	p. 22
		SL130	p. 22
		SL150AP	p. 15
		SL150AR	p. 15
		SL150BP	p. 15
		SL150BR	p. 15
		SL150CP	p. 15
		SL150CR	p. 15
		SL153A	p. 16
		SL153B	p. 16
		SL154A	p. 15
		SL154B	p. 15
		SL154C	p. 15
		SL159	p. 23
		SL160	p. 23
		SL161	p. 23
		SL162	p. 23
		SL164R	p. 13

SL165P	p. 13	SPB122Z	p. 49	WSL 15	pp. 25-26-27-28
SL165PCR	p. 13	SPBN120Z	p. 46	WSL 24	pp. 25-26-27-28
SL167CR	p. 13	SPN060	p. 38	WSL 25	pp. 25-26-27-28
SL201	p. 22	SPN061	p. 39	WSL 26	pp. 25-26-27-28
SL406M	p. 22	SPN062	p. 38	WSL 28	pp. 25-26-27-28
SL406P	p. 22	SPN063	p. 39	WSL 34	pp. 25-26-27-28
SL407M	p. 22	SPN068	p. 38	WSL 35	pp. 25-26-27-28
SL407P	p. 22	SPN069	p. 39	WSL 36	pp. 25-26-27-28
SLC400	p. 23	SPN070	p. 38	WSL 38	pp. 25-26-27-28
SLC800	p. 23	SPN071	p. 38	WSL 410	pp. 25-26-27-28
SP049	p. 33	SPN072	p. 38	WSL 44	pp. 25-26-27-28
SP050	p. 33	SPON120	p. 47	WSL 45	pp. 25-26-27-28
SP051	p. 33	SR047CR	p. 29	WSL 46	pp. 25-26-27-28
SP052	p. 34	SR12815	p. 30	WSL 48	pp. 25-26-27-28
SP053	p. 33	SR128CR	p. 29	WSL 510	pp. 25-26-27-28
SP054	p. 33	SR129CR	p. 29	WSL 54	pp. 25-26-27-28
SP055	p. 35	SR156	p. 30	WSL 55	pp. 25-26-27-28
SP056	p. 35	SR159	p. 30	WSL 56	pp. 25-26-27-28
SP056L	p. 35	SR160	p. 30	WSL 58	pp. 25-26-27-28
SP060	p. 38	SR161	p. 30	WSL 610	pp. 25-26-27-28
SP061	p. 39	SR162	p. 30	WSL 64	pp. 25-26-27-28
SP062	p. 38	SR163	p. 31	WSL 65	pp. 25-26-27-28
SP063	p. 39	SR163CR	p. 31	WSL 66	pp. 25-26-27-28
SP068	p. 38	ST134	p. 29	WSL 68	pp. 25-26-27-28
SP069	p. 39	ST135	p. 29	WSM 14	pp. 25-26-27-28
SP070	p. 38	ST136	p. 29	WSM 15	pp. 25-26-27-28
SP071	p. 38	ST137	p. 29	WSM 24	pp. 25-26-27-28
SP072	p. 38	ST138	p. 29	WSM 25	pp. 25-26-27-28
SP073	p. 39			WSM 26	pp. 25-26-27-28
SP074	p. 39			WSM 28	pp. 25-26-27-28
SP075	p. 39			WSM 34	pp. 25-26-27-28
SP11493	p. 34			WSM 35	pp. 25-26-27-28
SP139	p. 33			WSM 36	pp. 25-26-27-28
SP140	p. 33			WSM 38	pp. 25-26-27-28
SP141	p. 33			WSM 410	pp. 25-26-27-28
SP142	p. 33			WSM 44	pp. 25-26-27-28
SP143	p. 33			WSM 45	pp. 25-26-27-28
SP144	p. 33			WSM 46	pp. 25-26-27-28
SP145	p. 34			WSM 48	pp. 25-26-27-28
SP146	p. 34			WSM 510	pp. 25-26-27-28
SP147	p. 34			WSM 54	pp. 25-26-27-28
SP149	p. 36			WSM 55	pp. 25-26-27-28
SP151	p. 36			WSM 56	pp. 25-26-27-28
SP157	p. 36			WSM 58	pp. 25-26-27-28
SP158	p. 36			WSM 610	pp. 25-26-27-28
SP180	p. 33			WSM 64	pp. 25-26-27-28
SP181	p. 33			WSM 65	pp. 25-26-27-28
SP182	p. 33			WSM 66	pp. 25-26-27-28
SP183	p. 33			WSM 68	pp. 25-26-27-28
SP184	p. 33				
SP185	p. 33				
SP186	p. 33				
SP211	p. 33				
SP212	p. 33				
SP213	p. 33				
SP214	p. 33				
SP215	p. 33				
SP6000	p. 35				
SPAB215	p. 36				
SPB120Z	p. 48				
SPB121	p. 49				
SPB122A	p. 49				
SPB122CRA	p. 49				
SPB122CRZ	p. 49				
		V			
		VASN120	p. 47		
		VR	p. 11		
		W			
		WSH 14	pp. 25-26-27-28		
		WSH 15	pp. 25-26-27-28		
		WSH 24	pp. 25-26-27-28		
		WSH 25	pp. 25-26-27-28		
		WSH 26	pp. 25-26-27-28		
		WSH 28	pp. 25-26-27-28		
		WSH 34	pp. 25-26-27-28		
		WSH 35	pp. 25-26-27-28		
		WSH 36	pp. 25-26-27-28		
		WSH 38	pp. 25-26-27-28		
		WSH 410	pp. 25-26-27-28		
		WSH 44	pp. 25-26-27-28		
		WSH 45	pp. 25-26-27-28		
		WSH 46	pp. 25-26-27-28		
		WSH 48	pp. 25-26-27-28		
		WSH 510	pp. 25-26-27-28		
		WSH 54	pp. 25-26-27-28		
		WSH 55	pp. 25-26-27-28		
		WSH 56	pp. 25-26-27-28		
		WSH 58	pp. 25-26-27-28		
		WSH 610	pp. 25-26-27-28		
		WSH 64	pp. 25-26-27-28		
		WSH 65	pp. 25-26-27-28		
		WSH 66	pp. 25-26-27-28		
		WSH 68	pp. 25-26-27-28		
		WSL 14	pp. 25-26-27-28		







JUSTRITE ITALIA Srl
Via dei Prati Vecchi, 37 - 42025 Cavriago (RE)
Tel. +39 0522 941430 - info@sall.it - www.sall.it