



MOVIMENTAZIONE IN METALLO







La vostra sicurezza è la nostra priorità

L'azienda

La nostra storia

La storia di Sall inizia nel 1975 a Cavriago in un piccolo stabilimento artigianale specializzato nella lavorazione del metallo e nella produzione di contenitori industriali.

Negli anni '80, l'azienda amplia la propria gamma di prodotti progettando soluzioni innovative per la sicurezza nei luoghi di lavoro.

La crescita inarrestabile porta nel 2017 all'acquisizione di Sall da parte di Justrite Safety Group, leader globale nella sicurezza industriale.

Le nostre priorità

- Sicurezza delle persone e dell'ambiente
- Prodotti conformi alle norme e ai regolamenti UE
- Comfort, facilità di utilizzo e design unico per migliorare l'efficacia e facilitare ogni operazione.

Tutti i nostri prodotti standard e le nostre soluzioni su misura sono progettati e realizzati in conformità alle normative vigenti e sono testati per fornire il massimo livello di sicurezza per le persone, il posto di lavoro e l'ambiente.

Il gruppo

Una famiglia in crescita

Negli ultimi anni siamo cresciuti, espandendo Justrite Safety Group attraverso l'acquisizione di altre aziende forti e di valore. Questi cambiamenti entusiasmanti hanno dato vita a: un portafoglio di sicurezza senza rivali, una consolidata esperienza nella protezione ambientale, una rete globale di marchi e una dedizione costante alla sicurezza dei nostri clienti.

Inizia con l'Essenziale

L'essenza del nostro gruppo è racchiusa in uno slogan: *Start with the Essential*SM.

In Justrite, tutto inizia con la sicurezza. Proteggere le persone, la proprietà e il pianeta è la nostra prima e più grande responsabilità.

Scopri di più sul nostro sito www.sall.it

Justrite Brands



INDICE PRODOTTI PER CATEGORIA



CONTENITORI RIBALTABILI E FONDI APRIBILI

a. Contenitori portarottami ribaltabili

1. Contenitori portarottami ribaltabili a sgancio manuale pag. 7
2. Contenitori portarottami ribaltabili a sgancio dinamico pag. 12
3. Contenitori portarottami ribaltabili in rete pag. 12
4. Benne ribaltabili pag. 13
5. Contenitori portarottami ribaltabili per carrello elevatore a forche rotanti pag. 13

b. Contenitori a fondo apribile

1. Contenitori a un fondello apribile pag. 15
2. Contenitori a due fondelli apribili pag. 16



CONTENITORI PER L'INDUSTRIA

a. Contenitori in lamiera

1. Contenitori in lamiera di acciaio pag. 18
2. Contenitori in lamiera con slitta in piatto pag. 22
3. Contenitori a bocca di lupo pag. 22
4. Contenitori in lamiera ripieghevoli sovrapponibili pag. 23
5. Contenitori in lamiera ripieghevoli con coperchio pag. 23

b. Contenitori in rete

1. Contenitori in rete di acciaio pag. 25
2. Contenitori in rete con ruote pag. 29
3. Contenitori in rete modello Gitterbox pag. 30
4. Contenitori in rete ripieghevoli sovrapponibili pag. 30
5. Paretali in rete ripieghevoli pag. 30
6. Contenitori multifunzionali pag. 31



PALLET E PEDANE METALLICHE

a. Pallet a montanti liberi

1. Pallet a montanti liberi con piedi pag. 33
2. Pallet a montanti liberi con slitta pag. 33

3. Pallet a montanti liberi con piano in legno asportabile.....	pag. 34
4. Pallet con montanti sfilabili.....	pag. 34
5. Pallet porta barre.....	pag. 35
6. Pallet ripieghevoli sovrapponibili.....	pag. 36
7. Sponde per pallet in legno.....	pag. 36
8. Pallet porta stoffe.....	pag. 36

b. Pedane metalliche

1. Pedane metalliche con 2 slitte.....	pag. 38
2. Pedane metalliche con 3 slitte.....	pag. 39
3. Pedane metalliche a doppio fondo reversibile.....	pag. 39

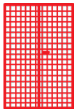

ARMADI E DEPOSITI PER BOMBOLE DI GAS

a. Box e depositi per bombole di gas

1. Depositati di sicurezza per bombole di gas compressi.....	pag. 41
2. Armadi di sicurezza per bombole di gas compressi.....	pag. 42

b. Pallet per il trasporto delle bombole di gas

1. Pallet per il trasporto di bombole di gas compressi.....	pag. 44
2. Carrelli e supporti per il trasporto di bombole di gas compressi.....	pag. 44



CONTENITORI PER LA RACCOLTA RIFIUTI

a. Contenitori porta big bag

1. Pallet porta big bag.....	pag. 46
2. Contenitori porta big bag con vasca di raccolta.....	pag. 49
3. Contenitori porta big bag con coperchio.....	pag. 49

CONTENITORI RIBALTABILI E FONDI APRIBILI

***a.* Contenitori portarottami ribaltabili**

La soluzione ideale per la raccolta, il trasporto e lo scarico di rifiuti industriali, trucioli, sfridi e rottami in modo facile e sicuro. Tutti i modelli di contenitori della linea Sall sono, infatti, dotati di sistemi di sicurezza, tra cui il meccanismo antiribaltamento e di scarico automatico da carrello elevatore.



Contenitori portarottami ribaltabili

Contenitori portarottami ribaltabili a sgancio manuale



La migliore soluzione per la raccolta, la movimentazione e lo scarico di rifiuti, sfridi e rottami in sicurezza.

- Sistema di svuotamento semplice e sicuro mediante leva azionabile a distanza dall'operatore (senza scendere dal carrello elevatore)
- Maneggevoli e di facile posizionamento di lavoro grazie a 4 ruote di grande diametro (2 fisse - 2 piroettanti)
- Ampia gamma di dimensioni
- Performance costanti nel tempo
- A richiesta: vasca di decantazione e rubinetto a sfera, coperchio rimovibile o incernierato, cilindro idraulico autonomo per un graduale ribaltamento.



CE

! E' disponibile la gamma completa di colori corrispondenti alle diverse tipologie di rifiuto.



DIMENSIONI SCATOLE DI INFORCAZIONE

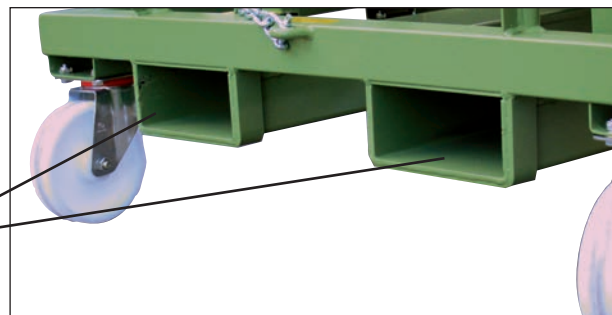
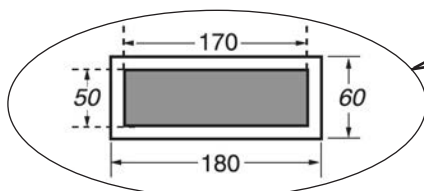

Contenitori portarottami ribaltabili

Contenitori portarottami ribaltabili a sgancio manuale

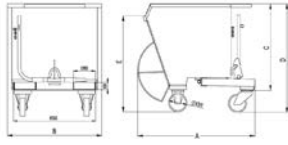

MODELLO	DIMENSIONI (mm)					Portata (kg)	Volume litri
	A	B	C	D	E		
LT 0280	970	750	700	890	790	600	280



**Modello
LT 0280**

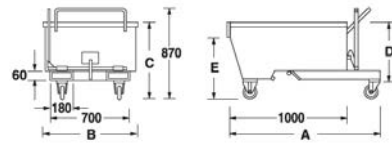

MODELLO	DIMENSIONI (mm)					Portata (kg)	Volume litri
	A	B	C	D	E		
LT 0300	1350	820	650	490	520	600	285



**Modello
LT 0300**

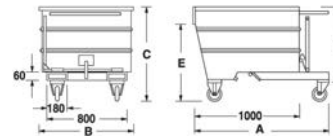

MODELLO	DIMENSIONI (mm)					Portata (kg)	Volume litri
	A	B	C	D	E		
LT 0500	1350	920	910	700	740	1000	490
LT 0750	1350	1070	1040	825	800	1350	755



Prodotti che rispettano i requisiti previsti dall'UE in materia di sicurezza, salute e tutela dell'ambiente.

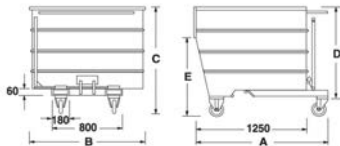

MODELLO	DIMENSIONI (mm)					Portata (kg)	Volume litri
	A	B	C	D	E		
LT 1000	1550	1070	1210	970	920	1700	1070
LT 1350	1550	1320	1210	970	920	2000	1320
LT 1600	1550	1550	1210	970	920	2000	1610
LT 2000	1550	1950	1210	970	920	2000	2040



**Modello
LT 1600**

Contenitori portarottami ribaltabili

Contenitori portarottami ribaltabili a sgancio manuale

ACCESSORI DISPONIBILI SU RICHIESTA:

1 VASCA DI DECANTAZIONE CON GRIGLIA FORI DIAM. 4 mm E RUBINETTO A SFERA PER SEPARARE LE SOSTANZE LIQUIDE DA QUELLE SOLIDE

Tutti i contenitori ribaltabili sono provvisti di:

- Manicotto
- Tappo da 1"
- Dado e relativa vite di chiusura M12 su fondo vasca.

In qualsiasi momento e al bisogno sarà quindi possibile in modo semplice ed immediato:

- Svitare il tappo e scaricare accumuli di liquidi
- Applicare il rubinetto a sfera (accessorio ordinabile separatamente)
- Applicare la griglia di decantazione (accessorio ordinabile separatamente).

Modello
VR

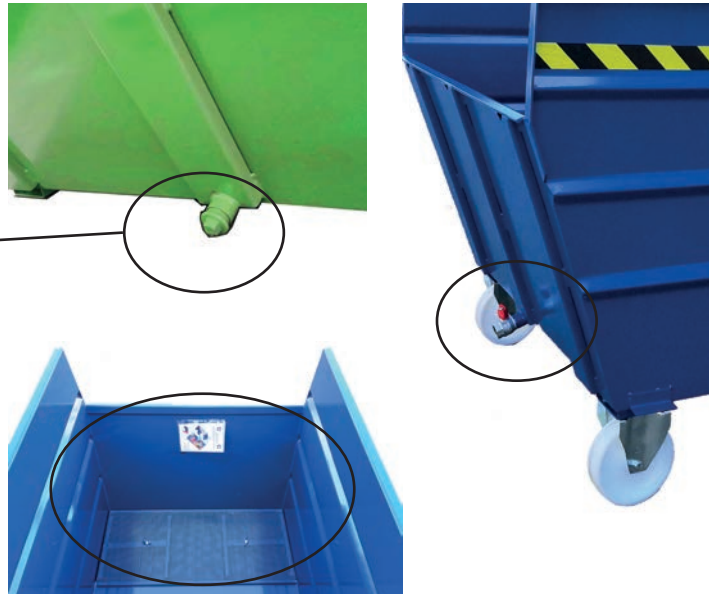

2 CILINDRO IDRAULICO AUTONOMO PER UN GRADUALE RIBALTAMENTO DEL PORTAROTTAMI

L'installazione dei cilindri non determina un aumento delle dimensioni, essendo montati all'interno dell'ingombro del portarottami. Per i modelli più grandi suggeriamo l'applicazione su entrambi i lati del cilindro idraulico, per garantire un miglior bilanciamento in fase di scarico.

Dal LT1600 al LT2000 è necessaria l'applicazione di 2 cilindri idraulici (vedi immagine **mod.CO60-380**).

Modello
CO60-380

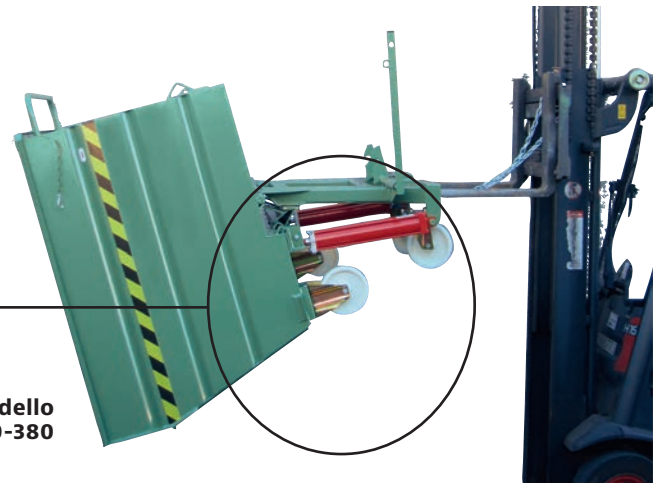

3 SPONDE FISSE AGGIUNTIVE IN RETE PER LA MOVIMENTAZIONE DI MATERIALI VOLUMINOSI

Le sponde fisse aumentano il volume del portarottami. Quando occorre raccogliere materiale ingombrante come carta, cartone, scatole, le sponde fisse aggiuntive conferiscono al contenitore un maggiore volume di raccolta.

Disponibili in rete o lamiera, con altezza 300 e 500 mm (misure standard) oppure personalizzati.



A richiesta tutti i contenitori possono essere realizzati in acciaio inox o zincati a caldo.



Contenitori portarottami ribaltabili

Contenitori portarottami ribaltabili a sgancio manuale

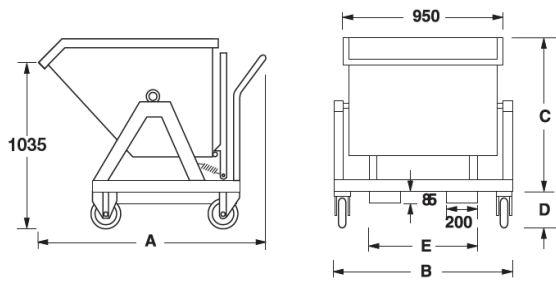

**Modello
LT 0450**

MODELLO	DIMENSIONI (mm)					Portata (kg)	Volume litri
	A	B	C	D	E		
LT 0450	1190	1070	935	210	620	1000	400



**Modello
LT 0460**

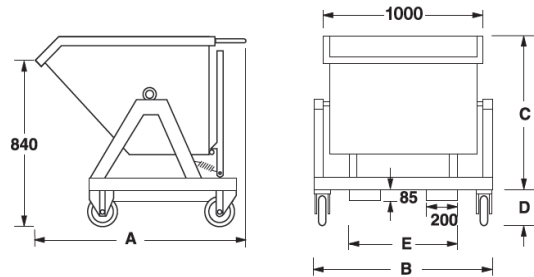

CE

Prodotti che rispettano i requisiti previsti dall'UE in materia di sicurezza, salute e tutela dell'ambiente.



MODELLO	DIMENSIONI (mm)					Portata (kg)	Volume litri
	A	B	C	D	E		
LT 0460	1175	1120	830	210	680	1000	438

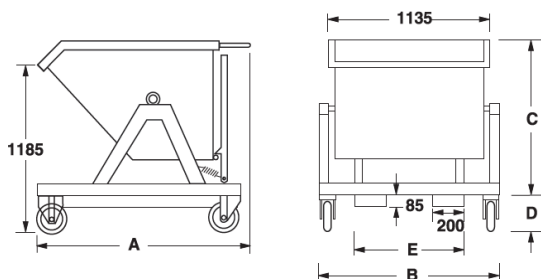

**Modello
LT 0470**

MODELLO	DIMENSIONI (mm)					Portata (kg)	Volume litri
	A	B	C	D	E		
LT 0470	1205	1260	1075	210	815	1000	675



Contenitori portarottami ribaltabili

Contenitori portarottami ribaltabili a sgancio manuale

ACCESSORI DISPONIBILI SU RICHIESTA:

- 1 COPERCHIO INCERNIERATO SDOPPIABILE A META'
- 2 COPERCHIO ASPORTABILE IN LAMIERA CON DUE MANIGLIE
- 3 TAPPI ANTIVIBRANTI IN GOMMA PER ATTUTTIRE L'URTO IN FASE DI RIBALTAMENTO



- 4 SCATOLE DI INFORCAZIONE CON COLLARE DI RINFORZO

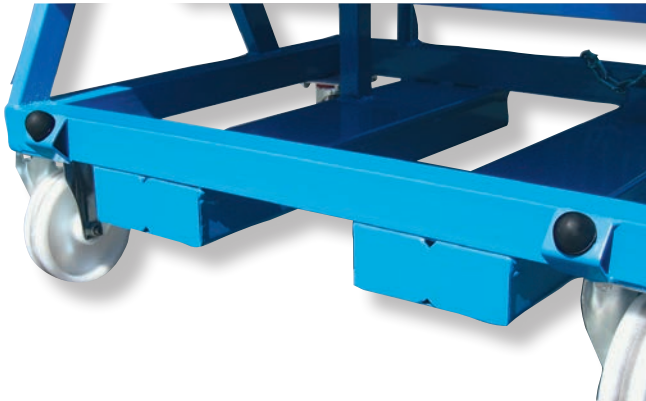

- 5 VASCA DI DECANTAZIONE CON GRIGLIA FORI DIAM. 4 MM E RUBINETTO A SFERA PER SEPARARE LE SOSTANZE LIQUIDE DA QUELLE SOLIDE



Modello VR

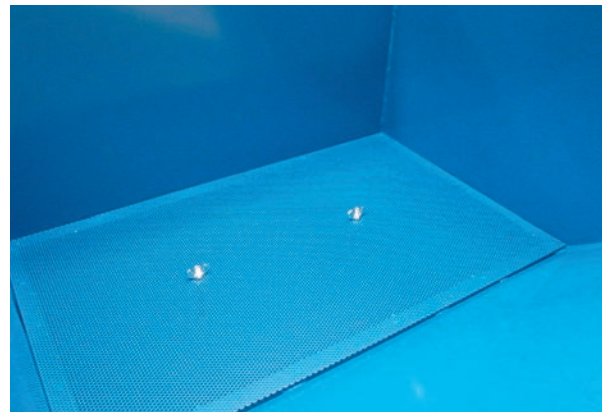

Contenitori portarottami ribaltabili

Contenitori portarottami ribaltabili a sgancio dinamico

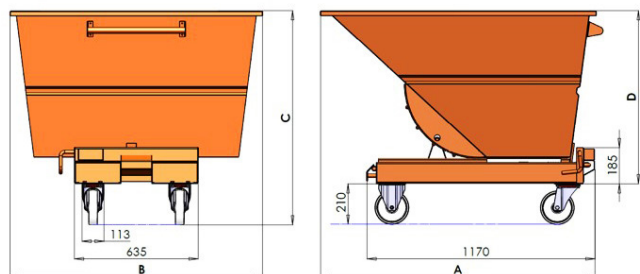

MODELLO	DIMENSIONI (mm)				Volume litri
	A	B	C	D	
SDC 550	1400	1000	1100	890	550
SDC 750	1400	1300	1100	890	750
SDC 1000	1570	1300	1250	1040	1000

Contenitori portarottami ribaltabili

Contenitori portarottami ribaltabili in rete



MODELLO	DIMENSIONI (mm)				Portata (kg)	Volume litri
	A	B	C	D		
LTR 1350	1550	1320	1210	970	2000	1320
LTR 1600	1550	1550	1210	970	2000	1610
LTR 2000	1550	1950	1210	970	2000	2040

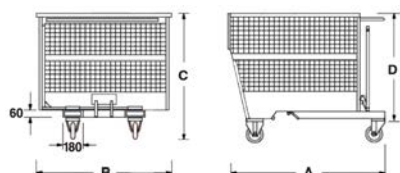

Prodotti che rispettano i requisiti previsti dall'UE in materia di sicurezza, salute e tutela dell'ambiente.



Modello LTR 2000

Contenitori portarottami ribaltabili Benne ribaltabili



MODELLO	DIMENSIONI (mm)			Portata (kg)
	A	B	C	
SL 164 R	1420	1270	570	1000

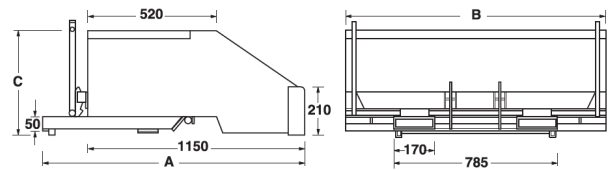

- Idonee per merci sfuse di tutti i tipi e per la neve
- Struttura particolarmente robusta
- Vasca a tenuta stagna
- Estremamente maneggevoli
- Complete di catena di sicurezza antislittamento
- Azionamento del ribaltamento a mezzo fune da carrello elevatore.

**Modello
SL 164R**



Prodotti che rispettano i requisiti previsti dall'UE in materia di sicurezza, salute e tutela dell'ambiente.

Contenitori portarottami ribaltabili Contenitori portarottami ribaltabili per carrello elevatore a forche rotanti



**Modello
SL 167 CR**



MODELLO	DIMENSIONI (mm)				Portata (kg)	Volume litri
	A	B	C	D		
SL 167 CR *	1130	1130	1010	240	1500	1145

*Con ruote e **coperchio**



- Ideali per la raccolta e lo smaltimento di tutti i tipi di rifiuti
- Svuotamento per rovesciamento tramite carrelli elevatori a forche rotanti.



MODELLO	DIMENSIONI (mm)				Portata (kg)	Volume litri
	A	B	C	D		
SL 165P	1210	1100	1080	100	1500	1350
SL 165PCR *	1210	1100	1080	240	1500	1350

*Con ruote

**Modello
SL 165P**





CONTENITORI RIBALTABILI E FONDI APRIBILI

b. ***Contenitori a fondo apribile***

La migliore soluzione
marcata CE per
raccolgere, stoccare,
trasportare
e scaricare mediante
carrello elevatore
materiali, scarti
produttivi e rifiuti
industriali in modo
efficiente e sicuro.

Contenitori a fondo apribile

Contenitori a un fondello apribile

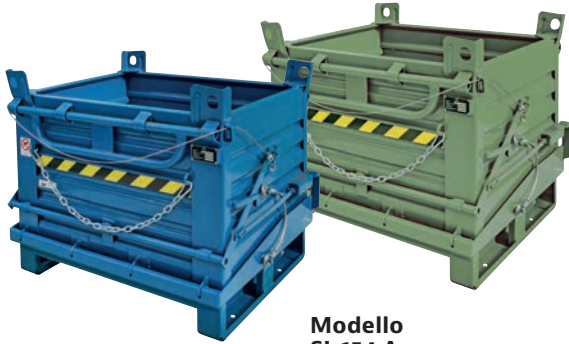

**Modello
SL 154 A**



Prodotti che rispettano i requisiti previsti dall'UE in materia di sicurezza, salute e tutela dell'ambiente.

MODELLO	DIMENSIONI (mm)					Portata (kg)
	A	B	C	D	E	
SL 154 A	1000	800	650	100	110	1300
SL 154 B	1200	1000	650	100	110	1400
SL 154 C	1500	1000	1000	100	110	1400

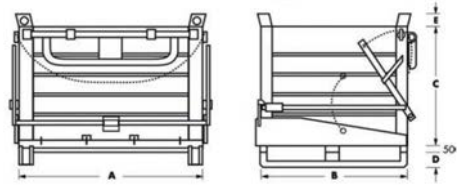

**Modello
SL 150 BP**

MODELLO	DIMENSIONI (mm)					Portata (kg)
	A	B	C	D	E	
SL 150 AP	1200	800	800	130	110	1350
SL 150 BP	1200	1000	800	130	110	1350
SL 150 CP	1500	1000	800	130	110	1350

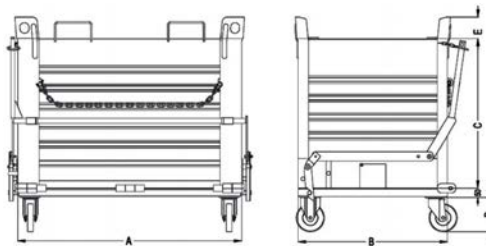

MODELLO	DIMENSIONI (mm)					Portata (kg)
	A	B	C	D	E	
SL 150 AR	1200	800	800	184	110	1350
SL 150 BR	1200	1000	800	184	110	1350
SL 150 CR	1500	1000	800	184	110	1350



**Modello
SL 150 BR**



Contenitori a fondo apribile

Contenitori a due fondelli apribili



**Modello
SL 064 H1000**

**Modello
SL 064 H650**



**Modello
SL 064 H1300**

MODELLO	DIMENSIONI (mm)					Portata (kg)
	A	B	C	D	E	
SL 064 H650	1000	800	650	110	110	2000
SL 064 H1000	1000	800	1000	110	110	2000
SL 064 H1300	1000	800	1300	110	110	2000



Prodotti che rispettano i requisiti previsti dall'UE in materia di sicurezza, salute e tutela dell'ambiente.



**Modello
SL 153 A**

**Modello
SL 153 B**



MODELLO	DIMENSIONI (mm)					Portata (kg)
	A	B	C	D	E	
SL 153 A	1500	1000	650	110	110	2000
SL 153 B	2000	1000	1000	110	110	2000

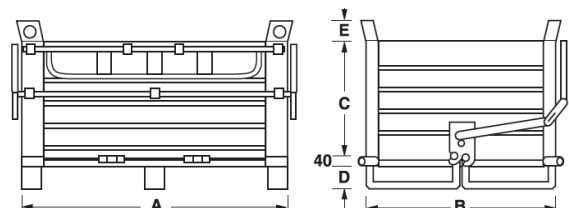

CONTENITORI PER L'INDUSTRIA

a. **Contenitori in lamiera**

I contenitori in lamiera Sall permettono di gestire nel modo più razionale la movimentazione e lo stoccaggio di grandi volumi di merci.

Sono disponibili in numerosi modelli, anche a tenuta stagna, con differenti conformazioni e dimensioni per soddisfare qualsiasi esigenza.



Contenitori in lamiera

Contenitori in lamiera di acciaio

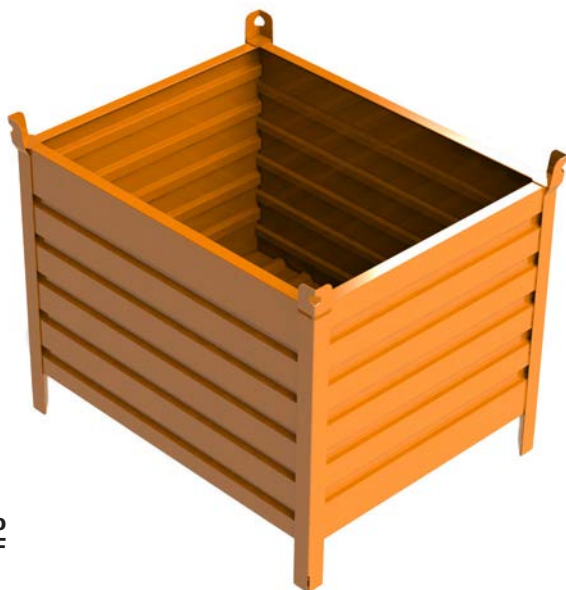

**Modello
MSL 26 F**



Su richiesta:

- Portaschede saldato
- Scritte, marchi, logotipi stampati in rilievo o verniciati.

Contenitori in lamiera - Con piede scatolato (F)



Base (mm)	Altezza utile (mm)	Serie leggera portata 1200 (kg)	Serie media portata 1700 (kg)	Serie pesante portata 2200 (kg)
800 x 600	400	MSL 14 F	MSM 14 F	MSH 14 F
800 x 600	500	MSL 15 F	MSM 15 F	MSH 15 F
1000 x 800	400	MSL 24 F	MSM 24 F	MSH 24 F
1000 x 800	500	MSL 25 F	MSM 25 F	MSH 25 F
1000 x 800	650	MSL 26 F	MSM 26 F	MSH 26 F
1000 x 800	800	MSL 28 F	MSM 28 F	MSH 28 F
1200 x 800	400	MSL 34 F	MSM 34 F	MSH 34 F
1200 x 800	500	MSL 35 F	MSM 35 F	MSH 35 F
1200 x 800	650	MSL 36 F	MSM 36 F	MSH 36 F
1200 x 800	800	MSL 38 F	MSM 38 F	MSH 38 F
1200 x 1000	400	MSL 44 F	MSM 44 F	MSH 44 F
1200 x 1000	500	MSL 45 F	MSM 45 F	MSH 45 F
1200 x 1000	650	MSL 46 F	MSM 46 F	MSH 46 F
1200 x 1000	800	MSL 48 F	MSM 48 F	MSH 48 F
1200 x 1000	1000	MSL 410 F	MSM 410 F	MSH 410 F
1500 x 800	400	MSL 54 F	MSM 54 F	MSH 54 F
1500 x 800	500	MSL 55 F	MSM 55 F	MSH 55 F
1500 x 800	650	MSL 56 F	MSM 56 F	MSH 56 F
1500 x 800	800	MSL 58 F	MSM 58 F	MSH 58 F
1500 x 800	1000	MSL 510 F	MSM 510 F	MSH 510 F
1500 x 1000	400	MSL 64 F	MSM 64 F	MSH 64 F
1500 x 1000	500	MSL 65 F	MSM 65 F	MSH 65 F
1500 x 1000	650	MSL 66 F	MSM 66 F	MSH 66 F
1500 x 1000	800	MSL 68 F	MSM 68 F	MSH 68 F
1500 x 1000	1000	MSL 610 F	MSM 610 F	MSH 610 F

Contenitori in lamiera

Contenitori in lamiera di acciaio



**Modello
MSL 25 SA**



Su richiesta:

- Portaschede saldato
- Scritte, marchi, logotipi stampati in rilievo o verniciati.

Contenitori in lamiera - Con slitta lato lungo (SA)



Base (mm)	Altezza utile (mm)	Serie leggera portata 1200 (kg)	Serie media portata 1700 (kg)	Serie pesante portata 2200 (kg)
800 x 600	400	MSL 14 SA	MSM 14 SA	MSH 14 SA
800 x 600	500	MSL 15 SA	MSM 15 SA	MSH 15 SA
1000 x 800	400	MSL 24 SA	MSM 24 SA	MSH 24 SA
1000 x 800	500	MSL 25 SA	MSM 25 SA	MSH 25 SA
1000 x 800	650	MSL 26 SA	MSM 26 SA	MSH 26 SA
1000 x 800	800	MSL 28 SA	MSM 28 SA	MSH 28 SA
1200 x 800	400	MSL 34 SA	MSM 34 SA	MSH 34 SA
1200 x 800	500	MSL 35 SA	MSM 35 SA	MSH 35 SA
1200 x 800	650	MSL 36 SA	MSM 36 SA	MSH 36 SA
1200 x 800	800	MSL 38 SA	MSM 38 SA	MSH 38 SA
1200 x 1000	400	MSL 44 SA	MSM 44 SA	MSH 44 SA
1200 x 1000	500	MSL 45 SA	MSM 45 SA	MSH 45 SA
1200 x 1000	650	MSL 46 SA	MSM 46 SA	MSH 46 SA
1200 x 1000	800	MSL 48 SA	MSM 48 SA	MSH 48 SA
1200 x 1000	1000	MSL 410 SA	MSM 410 SA	MSH 410 SA
1500 x 800	400	MSL 54 SA	MSM 54 SA	MSH 54 SA
1500 x 800	500	MSL 55 SA	MSM 55 SA	MSH 55 SA
1500 x 800	650	MSL 56 SA	MSM 56 SA	MSH 56 SA
1500 x 800	800	MSL 58 SA	MSM 58 SA	MSH 58 SA
1500 x 800	1000	MSL 510 SA	MSM 510 SA	MSH 510 SA
1500 x 1000	400	MSL 64 SA	MSM 64 SA	MSH 64 SA
1500 x 1000	500	MSL 65 SA	MSM 65 SA	MSH 65 SA
1500 x 1000	650	MSL 66 SA	MSM 66 SA	MSH 66 SA
1500 x 1000	800	MSL 68 SA	MSM 68 SA	MSH 68 SA
1500 x 1000	1000	MSL 610 SA	MSM 610 SA	MSH 610 SA

Contenitori in lamiera

Contenitori in lamiera di acciaio



**Modello
MSL 26 FDA**



Su richiesta:

- Portaschede saldato
- Scritte, marchi, logotipi stampati in rilievo o verniciati.

Contenitori in lamiera - Con piede scatolato (F) + portello lato lungo (DA)



Base (mm)	Altezza utile (mm)	Serie leggera portata 1200 (kg)	Serie media portata 1700 (kg)	Serie pesante portata 2200 (kg)
800 x 600	400	MSL 14 FDA	MSM 14 FDA	MSH 14 FDA
800 x 600	500	MSL 15 FDA	MSM 15 FDA	MSH 15 FDA
1000 x 800	400	MSL 24 FDA	MSM 24 FDA	MSH 24 FDA
1000 x 800	500	MSL 25 FDA	MSM 25 FDA	MSH 25 FDA
1000 x 800	650	MSL 26 FDA	MSM 26 FDA	MSH 26 FDA
1000 x 800	800	MSL 28 FDA	MSM 28 FDA	MSH 28 FDA
1200 x 800	400	MSL 34 FDA	MSM 34 FDA	MSH 34 FDA
1200 x 800	500	MSL 35 FDA	MSM 35 FDA	MSH 35 FDA
1200 x 800	650	MSL 36 FDA	MSM 36 FDA	MSH 36 FDA
1200 x 800	800	MSL 38 FDA	MSM 38 FDA	MSH 38 FDA
1200 x 1000	400	MSL 44 FDA	MSM 44 FDA	MSH 44 FDA
1200 x 1000	500	MSL 45 FDA	MSM 45 FDA	MSH 45 FDA
1200 x 1000	650	MSL 46 FDA	MSM 46 FDA	MSH 46 FDA
1200 x 1000	800	MSL 48 FDA	MSM 48 FDA	MSH 48 FDA
1200 x 1000	1000	MSL 410 FDA	MSM 410 FDA	MSH 410 FDA
1500 x 800	400	MSL 54 FDA	MSM 54 FDA	MSH 54 FDA
1500 x 800	500	MSL 55 FDA	MSM 55 FDA	MSH 55 FDA
1500 x 800	650	MSL 56 FDA	MSM 56 FDA	MSH 56 FDA
1500 x 800	800	MSL 58 FDA	MSM 58 FDA	MSH 58 FDA
1500 x 800	1000	MSL 510 FDA	MSM 510 FDA	MSH 510 FDA
1500 x 1000	400	MSL 64 FDA	MSM 64 FDA	MSH 64 FDA
1500 x 1000	500	MSL 65 FDA	MSM 65 FDA	MSH 65 FDA
1500 x 1000	650	MSL 66 FDA	MSM 66 FDA	MSH 66 FDA
1500 x 1000	800	MSL 68 FDA	MSM 68 FDA	MSH 68 FDA
1500 x 1000	1000	MSL 610 FDA	MSM 610 FDA	MSH 610 FDA

Contenitori in lamiera

Contenitori in lamiera di acciaio



**Modello
MSL 26 SADA**



Su richiesta:

- Portaschede saldato
- Scritte, marchi, logotipi stampati in rilievo o verniciati.

Contenitori in lamiera - Con slitta lato lungo (SA) + portello lato lungo (DA)



Base (mm)	Altezza utile (mm)	Serie leggera portata 1200 (kg)	Serie media portata 1700 (kg)	Serie pesante portata 2200 (kg)
800 x 600	400	MSL 14 SADA	MSM 14 SADA	MSH 14 SADA
800 x 600	500	MSL 15 SADA	MSM 15 SADA	MSH 15 SADA
1000 x 800	400	MSL 24 SADA	MSM 24 SADA	MSH 24 SADA
1000 x 800	500	MSL 25 SADA	MSM 25 SADA	MSH 25 SADA
1000 x 800	650	MSL 26 SADA	MSM 26 SADA	MSH 26 SADA
1000 x 800	800	MSL 28 SADA	MSM 28 SADA	MSH 28 SADA
1200 x 800	400	MSL 34 SADA	MSM 34 SADA	MSH 34 SADA
1200 x 800	500	MSL 35 SADA	MSM 35 SADA	MSH 35 SADA
1200 x 800	650	MSL 36 SADA	MSM 36 SADA	MSH 36 SADA
1200 x 800	800	MSL 38 SADA	MSM 38 SADA	MSH 38 SADA
1200 x 1000	400	MSL 44 SADA	MSM 44 SADA	MSH 44 SADA
1200 x 1000	500	MSL 45 SADA	MSM 45 SADA	MSH 45 SADA
1200 x 1000	650	MSL 46 SADA	MSM 46 SADA	MSH 46 SADA
1200 x 1000	800	MSL 48 SADA	MSM 48 SADA	MSH 48 SADA
1200 x 1000	1000	MSL 410 SADA	MSM 410 SADA	MSH 410 SADA
1500 x 800	400	MSL 54 SADA	MSM 54 SADA	MSH 54 SADA
1500 x 800	500	MSL 55 SADA	MSM 55 SADA	MSH 55 SADA
1500 x 800	650	MSL 56 SADA	MSM 56 SADA	MSH 56 SADA
1500 x 800	800	MSL 58 SADA	MSM 58 SADA	MSH 58 SADA
1500 x 800	1000	MSL 510 SADA	MSM 510 SADA	MSH 510 SADA
1500 x 1000	400	MSL 64 SADA	MSM 64 SADA	MSH 64 SADA
1500 x 1000	500	MSL 65 SADA	MSM 65 SADA	MSH 65 SADA
1500 x 1000	650	MSL 66 SADA	MSM 66 SADA	MSH 66 SADA
1500 x 1000	800	MSL 68 SADA	MSM 68 SADA	MSH 68 SADA
1500 x 1000	1000	MSL 610 SADA	MSM 610 SADA	MSH 610 SADA

Contenitori in lamiera

Contenitori in lamiera con
slitta in piatto

Slitta in piatto su tutti i lati

MODELLO	Larg. x Prof. (mm)	Altezza interna (mm)	Portata (kg)
SL407M	1100 x 725	600	1500
SL406M	1450 x 1100	600	1500
SL407P	1100 x 725	600	2000
SL406P	1450 x 1100	600	2000



Modello
SL407M

Contenitori in lamiera

Contenitori a bocca di lupo



MODELLO	Larg. x Prof. (mm)	Altezza interna (mm)	Portata (kg)
SL018	1000 x 800	500	1000
SL083	1000 x 800	650	1000
SL084	1200 x 800	650	1000



MODELLO	Larg. x Prof. (mm)	Altezza interna (mm)	Portata (kg)
SL011	800 x 600	410	600



MODELLO	Larg. x Prof. (mm)	Altezza interna (mm)	Portata (kg)
SL130	800 x 500	500	1000



MODELLO	Larg. x Prof. (mm)	Altezza interna (mm)	Portata (kg)
SL201	630 x 450	230	500



Contenitori in lamiera

Contenitori in lamiera ripieghevoli sovrapponibili



Modello
SL 159

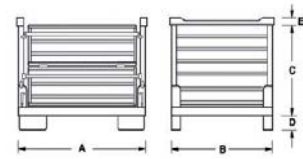

MODELLO	DIMENSIONI (mm)					Portata (kg)
	A	B	C	D	E	
SL 159	1000	800	620	100	45	1000
SL 160	1200	800	620	100	45	1000
SL 161	1200	1000	820	100	45	1000
SL 162	1500	1000	970	100	45	1000



Contenitori in lamiera

Contenitori in lamiera ripieghevoli con coperchio

MODELLO	DIMENSIONI (mm)					Portata (kg)
	A	B	C	D	E	
SLC 400	1200	800	410	120	65	1000
SLC 800	1200	800	795	120	65	1000



Modello
SLC 800



! Accatastabili sia da aperti che da chiusi e completi di: coperchio asportabile lucchettabile e maniglie di presa sui lati lunghi per una migliore apertura e chiusura.

Chiusura in cinque semplici mosse:

1



2



3



4



5



CONTENITORI PER L'INDUSTRIA

b. *Contenitori in rete*

Gamma completa di contenitori in rete adatti per la movimentazione e lo stoccaggio di svariati tipi di merce.

I contenitori Sall in rete risultano particolarmente utili nei casi in cui i prodotti contenuti debbano essere ben visibili. Ogni articolo è disponibile in differenti misure per venire incontro alle diverse necessità.

Contenitori in rete

Contenitori in rete di acciaio



Su richiesta:

- Portaschede saldato
- Scritte, marchi, logotipi stampati in rilievo o verniciati.

Modello
WSL 28 F

Contenitori in rete - Con piede scatolato (F)



Base (mm)	Altezza utile (mm)	Serie leggera portata 1200 (kg)	Serie media portata 1700 (kg)	Serie pesante portata 2200 (kg)
800 x 600	400	WSL 14 F	WSM 14 F	WSH 14 F
800 x 600	500	WSL 15 F	WSM 15 F	WSH 15 F
1000 x 800	400	WSL 24 F	WSM 24 F	WSH 24 F
1000 x 800	500	WSL 25 F	WSM 25 F	WSH 25 F
1000 x 800	650	WSL 26 F	WSM 26 F	WSH 26 F
1000 x 800	800	WSL 28 F	WSM 28 F	WSH 28 F
1200 x 800	400	WSL 34 F	WSM 34 F	WSH 34 F
1200 x 800	500	WSL 35 F	WSM 35 F	WSH 35 F
1200 x 800	650	WSL 36 F	WSM 36 F	WSH 36 F
1200 x 800	800	WSL 38 F	WSM 38 F	WSH 38 F
1200 x 1000	400	WSL 44 F	WSM 44 F	WSH 44 F
1200 x 1000	500	WSL 45 F	WSM 45 F	WSH 45 F
1200 x 1000	650	WSL 46 F	WSM 46 F	WSH 46 F
1200 x 1000	800	WSL 48 F	WSM 48 F	WSH 48 F
1200 x 1000	1000	WSL 410 F	WSM 410 F	WSH 410 F
1500 x 800	400	WSL 54 F	WSM 54 F	WSH 54 F
1500 x 800	500	WSL 55 F	WSM 55 F	WSH 55 F
1500 x 800	650	WSL 56 F	WSM 56 F	WSH 56 F
1500 x 800	800	WSL 58 F	WSM 58 F	WSH 58 F
1500 x 800	1000	WSL 510 F	WSM 510 F	WSH 510 F
1500 x 1000	400	WSL 64 F	WSM 64 F	WSH 64 F
1500 x 1000	500	WSL 65 F	WSM 65 F	WSH 65 F
1500 x 1000	650	WSL 66 F	WSM 66 F	WSH 66 F
1500 x 1000	800	WSL 68 F	WSM 68 F	WSH 68 F
1500 x 1000	1000	WSL 610 F	WSM 610 F	WSH 610 F

Contenitori in rete

Contenitori in rete di acciaio



Su richiesta:

- Portaschede saldato
- Scritte, marchi, logotipi stampati in rilievo o verniciati.

Modello
WSL 28 SA

Contenitori in rete - Con slitta lato lungo (SA)



Base (mm)	Altezza utile (mm)	Serie leggera portata 1200 (kg)	Serie media portata 1700 (kg)	Serie pesante portata 2200 (kg)
800 x 600	400	WSL 14 SA	WSM 14 SA	WSH 14 SA
800 x 600	500	WSL 15 SA	WSM 15 SA	WSH 15 SA
1000 x 800	400	WSL 24 SA	WSM 24 SA	WSH 24 SA
1000 x 800	500	WSL 25 SA	WSM 25 SA	WSH 25 SA
1000 x 800	650	WSL 26 SA	WSM 26 SA	WSH 26 SA
1000 x 800	800	WSL 28 SA	WSM 28 SA	WSH 28 SA
1200 x 800	400	WSL 34 SA	WSM 34 SA	WSH 34 SA
1200 x 800	500	WSL 35 SA	WSM 35 SA	WSH 35 SA
1200 x 800	650	WSL 36 SA	WSM 36 SA	WSH 36 SA
1200 x 800	800	WSL 38 SA	WSM 38 SA	WSH 38 SA
1200 x 1000	400	WSL 44 SA	WSM 44 SA	WSH 44 SA
1200 x 1000	500	WSL 45 SA	WSM 45 SA	WSH 45 SA
1200 x 1000	650	WSL 46 SA	WSM 46 SA	WSH 46 SA
1200 x 1000	800	WSL 48 SA	WSM 48 SA	WSH 48 SA
1200 x 1000	1000	WSL 410 SA	WSM 410 SA	WSH 410 SA
1500 x 800	400	WSL 54 SA	WSM 54 SA	WSH 54 SA
1500 x 800	500	WSL 55 SA	WSM 55 SA	WSH 55 SA
1500 x 800	650	WSL 56 SA	WSM 56 SA	WSH 56 SA
1500 x 800	800	WSL 58 SA	WSM 58 SA	WSH 58 SA
1500 x 800	1000	WSL 510 SA	WSM 510 SA	WSH 510 SA
1500 x 1000	400	WSL 64 SA	WSM 64 SA	WSH 64 SA
1500 x 1000	500	WSL 65 SA	WSM 65 SA	WSH 65 SA
1500 x 1000	650	WSL 66 SA	WSM 66 SA	WSH 66 SA
1500 x 1000	800	WSL 68 SA	WSM 68 SA	WSH 68 SA
1500 x 1000	1000	WSL 610 SA	WSM 610 SA	WSH 610 SA

Contenitori in rete

Contenitori in rete di acciaio



Su richiesta:

- Portaschede saldato
- Scritte, marchi, logotipi stampati in rilievo o verniciati.

Modello
WSL 28 FDA

Contenitori in rete - Con piede scatolato (F) + portello lato lungo (DA)



Base (mm)	Altezza utile (mm)	Serie leggera portata 1200 (kg)	Serie media portata 1700 (kg)	Serie pesante portata 2200 (kg)
800 x 600	400	WSL 14 FDA	WSM 14 FDA	WSH 14 FDA
800 x 600	500	WSL 15 FDA	WSM 15 FDA	WSH 15 FDA
1000 x 800	400	WSL 24 FDA	WSM 24 FDA	WSH 24 FDA
1000 x 800	500	WSL 25 FDA	WSM 25 FDA	WSH 25 FDA
1000 x 800	650	WSL 26 FDA	WSM 26 FDA	WSH 26 FDA
1000 x 800	800	WSL 28 FDA	WSM 28 FDA	WSH 28 FDA
1200 x 800	400	WSL 34 FDA	WSM 34 FDA	WSH 34 FDA
1200 x 800	500	WSL 35 FDA	WSM 35 FDA	WSH 35 FDA
1200 x 800	650	WSL 36 FDA	WSM 36 FDA	WSH 36 FDA
1200 x 800	800	WSL 38 FDA	WSM 38 FDA	WSH 38 FDA
1200 x 1000	400	WSL 44 FDA	WSM 44 FDA	WSH 44 FDA
1200 x 1000	500	WSL 45 FDA	WSM 45 FDA	WSH 45 FDA
1200 x 1000	650	WSL 46 FDA	WSM 46 FDA	WSH 46 FDA
1200 x 1000	800	WSL 48 FDA	WSM 48 FDA	WSH 48 FDA
1200 x 1000	1000	WSL 410 FDA	WSM 410 FDA	WSH 410 FDA
1500 x 800	400	WSL 54 FDA	WSM 54 FDA	WSH 54 FDA
1500 x 800	500	WSL 55 FDA	WSM 55 FDA	WSH 55 FDA
1500 x 800	650	WSL 56 FDA	WSM 56 FDA	WSH 56 FDA
1500 x 800	800	WSL 58 FDA	WSM 58 FDA	WSH 58 FDA
1500 x 800	1000	WSL 510 FDA	WSM 510 FDA	WSH 510 FDA
1500 x 1000	400	WSL 64 FDA	WSM 64 FDA	WSH 64 FDA
1500 x 1000	500	WSL 65 FDA	WSM 65 FDA	WSH 65 FDA
1500 x 1000	650	WSL 66 FDA	WSM 66 FDA	WSH 66 FDA
1500 x 1000	800	WSL 68 FDA	WSM 68 FDA	WSH 68 FDA
1500 x 1000	1000	WSL 610 FDA	WSM 610 FDA	WSH 610 FDA

Contenitori in rete

Contenitori in rete di acciaio



Su richiesta:

- Portaschede saldato
- Scritte, marchi, logotipi stampati in rilievo o verniciati.

Modello
WSL 28 SADA

Contenitori in rete - Con slitta lato lungo (SA) + portello lato lungo (DA)



Base (mm)	Altezza utile (mm)	Serie leggera portata 1200 (kg)	Serie media portata 1700 (kg)	Serie pesante portata 2200 (kg)
800 x 600	400	WSL 14 SADA	WSM 14 SADA	WSH 14 SADA
800 x 600	500	WSL 15 SADA	WSM 15 SADA	WSH 15 SADA
1000 x 800	400	WSL 24 SADA	WSM 24 SADA	WSH 24 SADA
1000 x 800	500	WSL 25 SADA	WSM 25 SADA	WSH 25 SADA
1000 x 800	650	WSL 26 SADA	WSM 26 SADA	WSH 26 SADA
1000 x 800	800	WSL 28 SADA	WSM 28 SADA	WSH 28 SADA
1200 x 800	400	WSL 34 SADA	WSM 34 SADA	WSH 34 SADA
1200 x 800	500	WSL 35 SADA	WSM 35 SADA	WSH 35 SADA
1200 x 800	650	WSL 36 SADA	WSM 36 SADA	WSH 36 SADA
1200 x 800	800	WSL 38 SADA	WSM 38 SADA	WSH 38 SADA
1200 x 1000	400	WSL 44 SADA	WSM 44 SADA	WSH 44 SADA
1200 x 1000	500	WSL 45 SADA	WSM 45 SADA	WSH 45 SADA
1200 x 1000	650	WSL 46 SADA	WSM 46 SADA	WSH 46 SADA
1200 x 1000	800	WSL 48 SADA	WSM 48 SADA	WSH 48 SADA
1200 x 1000	1000	WSL 410 SADA	WSM 410 SADA	WSH 410 SADA
1500 x 800	400	WSL 54 SADA	WSM 54 SADA	WSH 54 SADA
1500 x 800	500	WSL 55 SADA	WSM 55 SADA	WSH 55 SADA
1500 x 800	650	WSL 56 SADA	WSM 56 SADA	WSH 56 SADA
1500 x 800	800	WSL 58 SADA	WSM 58 SADA	WSH 58 SADA
1500 x 800	1000	WSL 510 SADA	WSM 510 SADA	WSH 510 SADA
1500 x 1000	400	WSL 64 SADA	WSM 64 SADA	WSH 64 SADA
1500 x 1000	500	WSL 65 SADA	WSM 65 SADA	WSH 65 SADA
1500 x 1000	650	WSL 66 SADA	WSM 66 SADA	WSH 66 SADA
1500 x 1000	800	WSL 68 SADA	WSM 68 SADA	WSH 68 SADA
1500 x 1000	1000	WSL 610 SADA	WSM 610 SADA	WSH 610 SADA

Contenitori in rete

Contenitori in rete con ruote



Modello
SR047 CR



MODELLO	Larg. x Prof. (mm)	Altezza interna (mm)	Portata (kg)
SR047 CR	1000 x 800	600	800
SR128 CR	1200 x 800	600	800
SR129 CR	1500 x 800	600	800



Disponibili anche nella versione con pareti in lamiera.



Modello
SL047 CR

Telaio con ruote per movimentazione contenitori

MODELLO	DIMENSIONI (mm)			Portata (kg)
	A	B	C	
ST 134	830	530	240	800
ST 135	830	630	240	800
ST 136	1030	830	240	800
ST 137	1230	830	240	800
ST 138	1230	1030	240	800



Modello
ST134

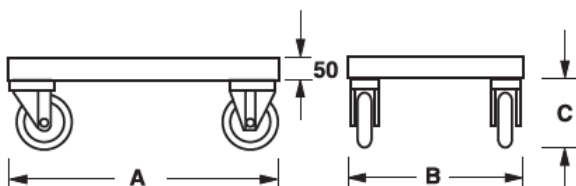

Telaio con ruote disponibile anche per i contenitori in lamiera.

Contenitori in rete

Contenitori in rete modello Gitterbox



Modello SR 12815

MODELLO	DIMENSIONI (mm)			Portata (kg)
	Larg.	Prof.	Alt.	
SR12815	1225	820	970	1000



Su richiesta accessoriabili con portasciede removibili (**modello PCLI/310210Z**).

Contenitori in rete

Contenitori in rete ripieghevoli sovrapponibili

MODELLO	DIMENSIONI (mm)					Portata (kg)
	A	B	C	D	E	
SR 159	1000	800	620	100	45	1000
SR 160	1200	800	620	100	45	1000
SR 161	1200	1000	820	100	45	1000
SR 162	1500	1000	970	100	45	1000



Modello SR159

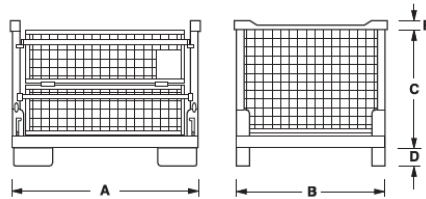

Contenitori in rete

Pareti in rete ripieghevoli



Modello SR 156

MODELLO	DIMENSIONI (mm)					Portata (kg)
	A	B	C	D	E	
SR 156	1215	815	800	100	40	1000

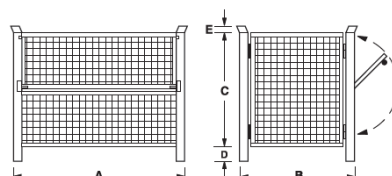

Contenitori in rete

Contenitori multifunzionali

MODELLO	DIMENSIONI (mm)				Portata (kg)
	A	B	C	D	
SR 163	1000	1000	1100	60	-



Completo di:

- Sponda in rete tech a protezione dell'operatore dotata di un cilindro a gas che ne facilita l'apertura e la chiusura, semplificando anche le operazioni di stivaggio del prodotto quando non in uso
- Porta di accesso richiudibile automaticamente a battuta antivibrante, apribile solo verso l'interno e dotata di chiusura di sicurezza
- Piano in gomma di sicurezza antiscivolo e antistatico
- Vaschetta porta attrezzi in polistirene antiurto
- Dispositivo di sicurezza antisfilamento accidentale delle forche
- Attacchi per utilizzo di cinture di sicurezza (non comprese).

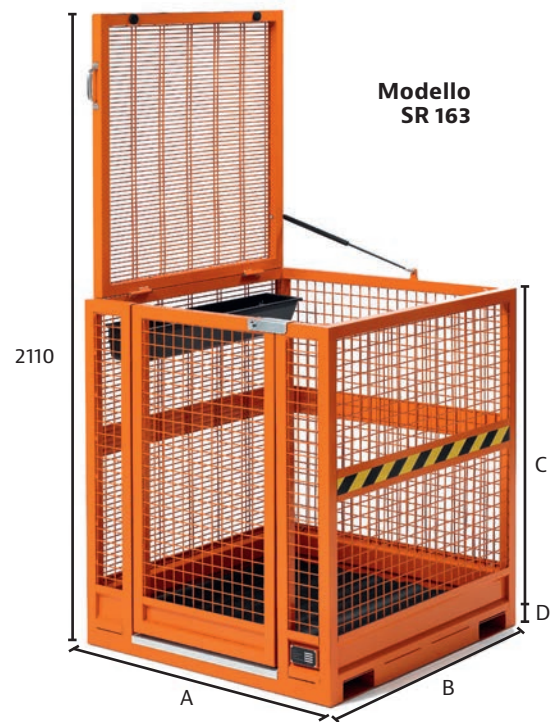

Su richiesta disponibile con ruote: 2 fisse e 2 piroettanti con freno (**modello SR 163 CR**).

PALLET E PEDANE METALLICHE

a. ***Pallet a montanti liberi***

I pallet a montanti liberi sono pallet sovrapponibili in metallo ad elevata portata che permettono la movimentazione con carrello elevatore e lo stoccaggio in verticale di merci e materiali ingombranti a magazzino. Tutti i pallet sovrapponibili presentano una resistente e durevole struttura in acciaio con montanti liberi agli angoli e sono disponibili in diverse versioni.

Pallet a montanti liberi

Pallet a montanti liberi con piedi



Modello SP051

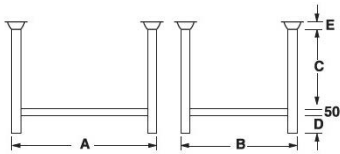

MODELLO	DIMENSIONI (mm)					Portata (kg)
	A	B	C	D	E	
SP051	1000	800	580	120	40	1000
SP180	1000	800	800	120	40	1000
SP053	1200	800	580	120	40	1000
SP181	1200	800	800	120	40	1000
SP054	1200	1000	580	120	40	1000
SP182	1200	1000	800	120	40	1000
SP144	1500	800	580	120	40	1000

Pallet a montanti liberi

Pallet a montanti liberi con slitta



MODELLO	DIMENSIONI (mm)					Portata (kg)
	A	B	C	D	E	
SP050	1000	800	600	120	60	1500
SP184	1000	800	800	150	60	1500
SP141	1200	800	600	150	60	1500
SP185	1200	800	800	150	60	1500
SP142	1200	1000	600	150	60	1500
SP186	1200	1000	800	150	60	1500
SP143	1500	800	600	150	60	1500
SP183	1500	1000	600	150	60	1500



Disponibili su richiesta con piede con tazza alla base.

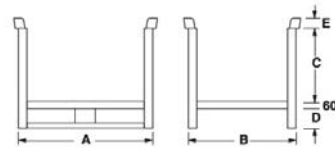

Modello SP050

MODELLO	DIMENSIONI (mm)					Portata (kg)
	A	B	C	D	E	
SP049	1000	800	610	150	110	1500
SP139	1200	800	610	150	110	1500
SP140	1200	1000	610	150	110	1500

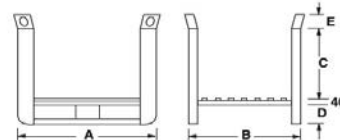

Modello SP049

MODELLO	DIMENSIONI (mm)					Portata (kg)
	A	B	C	D	E	
SP211	1000	800	610	110	90	2000
SP212	1200	800	610	110	90	2000
SP213	1200	1000	610	110	90	2000
SP214	1500	800	610	110	90	2000
SP215	1500	1000	610	110	90	2000

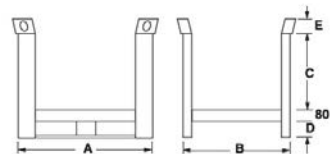

Modello SP211

Pallet a montanti liberi

Pallet a montanti liberi con piano in legno asportabile



Modello
SP052



MODELLO	DIMENSIONI (mm)					Portata (kg)
	A	B	C	D	E	
SP052	1000	800	565	120	40	1000
SP145	1200	800	565	120	40	1000
SP146	1200	1000	565	120	40	1000
SP147	1500	800	565	120	40	1000

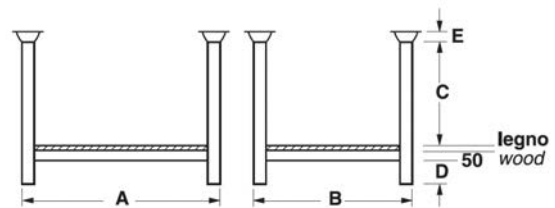

Pallet a montanti liberi

Pallet con montanti sfilabili



MODELLO	DIMENSIONI (mm)			Portata (kg)
	A	B	C	
SP 11493	1500	790	1100	1000

Modello
SP 11493

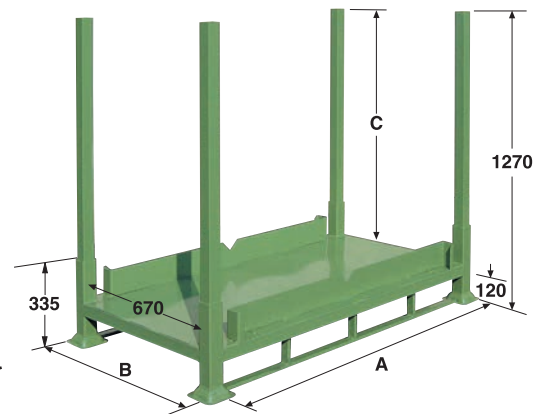

Pallet particolarmente versatile. I montanti sono facilmente sfilabili a mano dalla loro sede. Una volta tolti e posizionati negli appositi alloggi consentono di ottimizzare gli spazi in fase di magazzinaggio e trasporto.

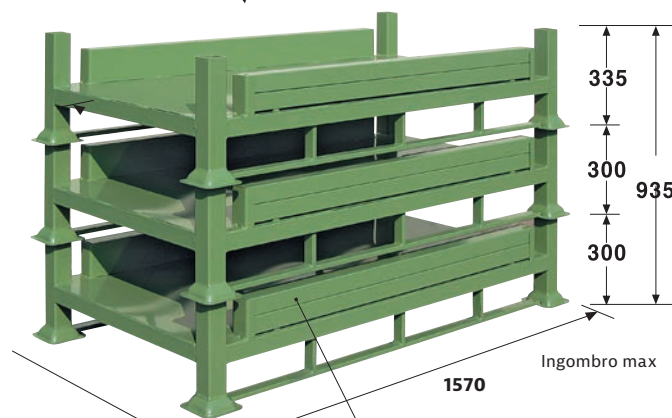

ALLOGGIO DEI MONTANTI ASPORTABILI



Modelli certificati per essere:

- Sollevabili con gru o carroponte
- Accessoriabili con piano in lamiera, ruote (escluso **modello SP6000**) e staffe di inforcazione
- Possibilità di chiudere i lati interni con pareti in lamiera o rete e/o traverse per lo stoccaggio di tubolari/barre di piccole dimensioni
- Sovrapponibili 1 + 2.

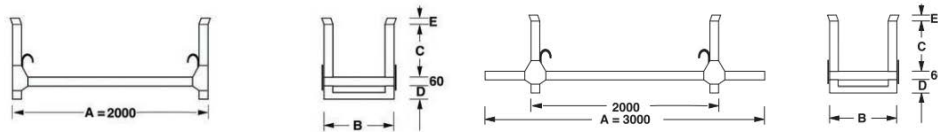

MODELLO	DIMENSIONI (mm)					Portata (kg)
	A	B	C	D	E	
SP055	2000	560	500	100	60	2000
SP056	3000	560	500	100	60	3000



Modello SP056L

Modello SP6000

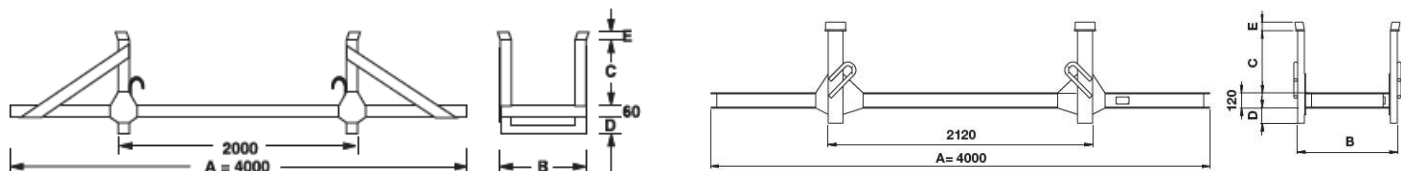
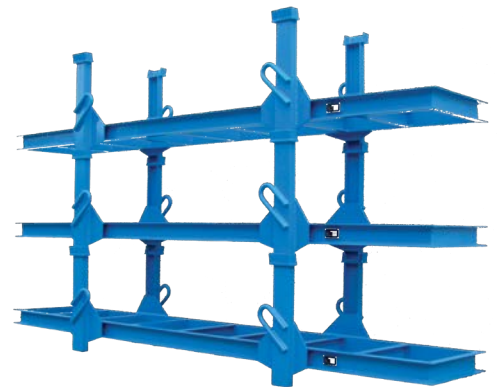

MODELLO	DIMENSIONI (mm)					Portata (kg)
	A	B	C	D	E	
SP056L	4000	560	500	100	60	3000
SP6000	4000	800	490	120	70	6000

Pallet a montanti liberi

Pallet ripieghevole sovrapponibili



MODELLO	DIMENSIONI (mm)							Portata (kg)
	A	B	C	D	E	F	G	
SP 157	1200	800	800	150	50	1290	890	800
SP 158	1200	1000	800	150	50	1290	1090	800

Modello
SP 157

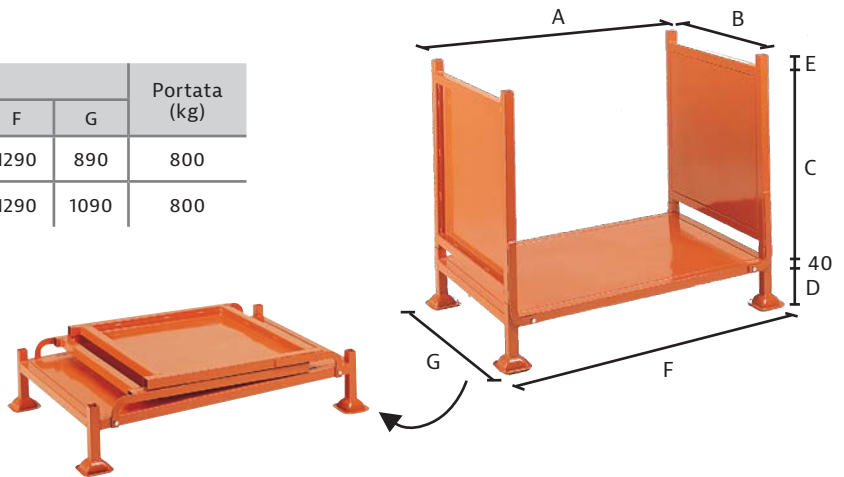

Pallet a montanti liberi

Sponde per pallet in legno



Modello
SPAB215



MODELLO	DIMENSIONI (mm)			Portata (kg)
	Larg.	Prof.	Alt.	
SPAB215	1208	808	980	1000

*Per Europallet

Pallet a montanti liberi

Pallet porta stoffe



MODELLO	DIMENSIONI (mm)					Portata (kg)
	A	B	C	D	E	
SP149	1500	800	800	120	60	1000
SP151	1500	1000	800	120	60	1000



• Sovrapponibili.

Modello
SP149

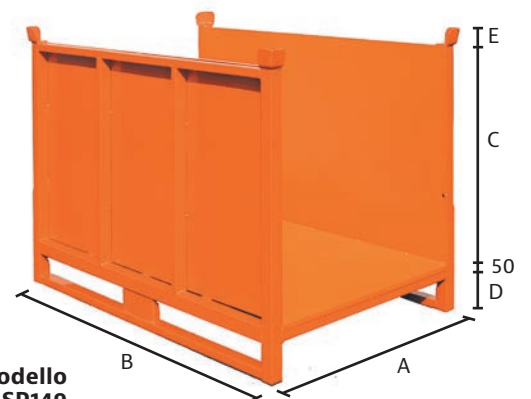



PALLET E PEDANE METALLICHE

***b.* Pedane metalliche**

Adatte al trasporto, movimentazione e stoccaggio di merci e materiali pesanti a magazzino, le pedane Sall sono realizzate in acciaio al carbonio e disponibili zincate o verniciate a polvere. Ideali per carichi pesanti, logistica e per quei settori che richiedono un'elevata resistenza, durata e portata.

Pedane metalliche

Pedane metalliche con 2 slitte



Modello SPN060
(greche trasversali)

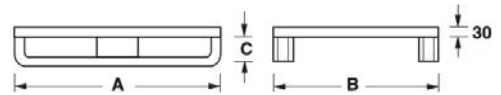

MODELLO	DIMENSIONI (mm)			Portata (kg)
	A	B	C	
SPN060	1000	800	120	1000
SPN062	1200	800	120	1000
SPN068	1200	1000	120	1000

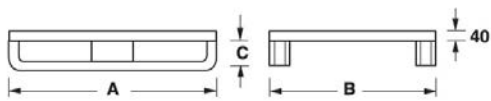

MODELLO	DIMENSIONI (mm)			Portata (kg)
	A	B	C	
SP060	1000	800	120	1500
SP062	1200	800	120	1500
SP068	1200	1000	120	1500



Modello SP060
(greche longitudinali)



Modello SP070
(fondo in lamiera + piano in legno)

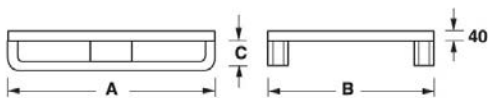

MODELLO	DIMENSIONI (mm)			Portata (kg)
	A	B	C	
SPN070	1000	800	120	1000
SPN071	1200	800	120	1000
SPN072	1200	1000	120	1000



MODELLO	DIMENSIONI (mm)			Portata (kg)
	A	B	C	
SP070	1000	800	120	1500
SP071	1200	800	120	1500
SP072	1200	1000	120	1500



Modello SP070
(fondo in lamiera + piano in legno)

Pedane metalliche

Pedane metalliche con 3 slitte



Modello SPN061
(greche trasversali)

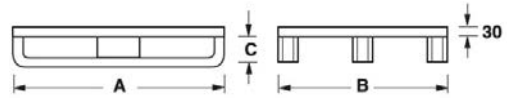

MODELLO	DIMENSIONI (mm)			Portata (kg)
	A	B	C	
SPN061	1000	800	120	1500
SPN063	1200	800	120	1500
SPN069	1200	1000	120	1500

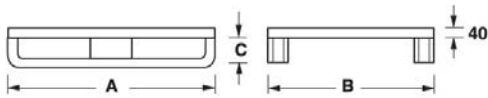

MODELLO	DIMENSIONI (mm)			Portata (kg)
	A	B	C	
SP061	1000	800	120	2000
SP063	1200	800	120	2000
SP069	1200	1000	120	2000



Modello SP061
(greche longitudinali)

Pedane metalliche

Pedane metalliche a doppio fondo reversibile



Modello SP073

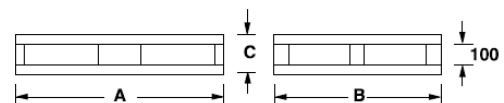

MODELLO	DIMENSIONI (mm)			Portata (kg)
	A	B	C	
SP 073	1000	800	180	2000
SP 074	1200	800	180	2000
SP 075	1200	1000	180	2000



IMPORTANTE

La movimentazione delle pedane deve avvenire sempre una alla volta. Le pedane sono progettate appositamente per essere inforcate e spostate con transpallet o carrello elevatore; effettuare movimenti con le forche di sollevamento inclinate verso l'operatore.

ARMADI E DEPOSITI PER BOMBOLE DI GAS

α. ***Box e Depositi per bombole di gas***

La vasta gamma Sall offre depositi e box per bombole configurati come gabbie e depositi modulari dotati di chiusura antintrusione e progettati per garantire lo stoccaggio a norma e in sicurezza fino a 36 bombole. Tutti i modelli sono personalizzabili per dimensioni e accessori. Per particolari esigenze si realizzano depositi per bombole su misura.



Box e depositi per bombole di gas

Depositi di sicurezza per bombole di gas compressi



**Modello
PANDESA 3**

MODELLO	Misure esterne Larg. x Prof. x Alt. (mm)	Capacità bombole	Portata (kg)
PANDESA 3	960 x 880 x 2400	3 bombole gas	262
PANDESA 6	1760 x 880 x 2400	6 bombole gas	377
PANDESA 6+3	2640 x 880 x 2400	9 bombole gas	568
PANDESA 10	1760 x 1680 x 2400	10 bombole gas	550



Certificato dal Ministero degli Interni Cert. nr. 3804/30/91.

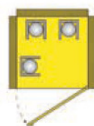

**Modello
PANDESA 3**

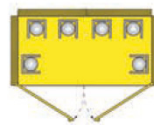

**Modello
PANDESA 6**

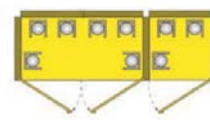

**Modello
PANDESA 6 + 3**

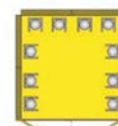

**Modello
PANDESA 10**



**Modello
PBO 15 SB Z**

**Modello
PBO 15 CB Z**

Rampa disponibile su
richiesta
**(modello
RAPBO 15 Z)**

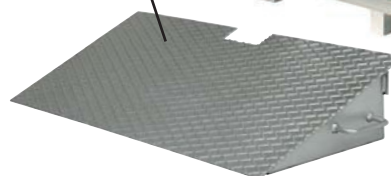

MODELLO	Misure esterne Larg. x Prof. x Alt. (mm)	Capacità bombole
PBO 15 SB Z senza basamento	1550 x 1210 x 2285	1 pallet + 4 bombole oppure 2 scomparti ognuno di 3 file da 4 bombole
PBO 15 CB Z con basamento	1550 x 1210 x 2450	1 pallet + 4 bombole oppure 2 scomparti ognuno di 3 file da 4 bombole
PBO 30 SB Z senza basamento	3180 x 1600 x 2285	2 pallet + 8 bombole oppure 4 scomparti ognuno di 3 file da 4 bombole
PBO 30 CB Z con basamento	3180 x 1600 x 2450	2 pallet + 8 bombole oppure 4 scomparti ognuno di 3 file da 4 bombole

Box e depositi per bombole di gas

Depositi di sicurezza per bombole di gas compressi



**Modello
PBO 11 CBZ**

Rampa disponibile su richiesta
**(modello
RAPBO 11 CBZ)**



A richiesta ripiano
rimovibile per stoccare
bombole di piccole
dimensioni
**(modello
PBO 11 CBZ/1R)**

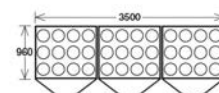
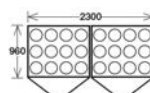

MODELLO	PBO 11 CBZ	PBO 23 CBZ	PBO 35 CBZ
Numero di bombole 50 l diam. 230 mm	12	24	36
Larg. x Prof. x Alt. (mm)	960 x 1130 x 2100	960 x 2300 x 2100	960 x 3500 x 2100

Box e depositi per bombole di gas

Armadi di sicurezza per bombole di gas compressi



Armadi di sicurezza per lo stoccaggio di bombole gas compressi con classe di resistenza al fuoco G 30 minuti certificato secondo EN 14470-2 EN 16121 REPORT LAPI n° 771.0 EN 0150/13.

Accessoriabili con:

- Aspiratore antiscintilla in box metallico (**mod. DIAM 125 BP**)
- Filtro a carbone attivo (**mod. R SOL**)
- Estintore automatico interno o esterno (**mod. ESTINTORE**).



**Modello
B 120 G30**

**Modello
B 60 G30**



MODELLO	Misure esterne Larg. x Prof. x Alt. (mm)	Porta	Capacità bombole
B60 G30	590 x 600 x 2050	1 battente	1/2
B120 G30	1190 x 600 x 2050	2 battenti	3/4

ARMADI E DEPOSITI PER BOMBOLE DI GAS

b. ***Pallet per il trasporto delle bombole di gas***

I cestelli portabombole prodotti da Sall sono pallet specifici per lo stoccaggio e il trasporto di bombole di gas che possono essere movimentati in sicurezza sia con carrello elevatore che con gru.

Realizzati con una robusta struttura in acciaio zincato a caldo, sono dotati di staffa di fissaggio e dispositivo di sicurezza per prevenire accidentali cadute delle bombole di gas durante il trasporto in modo da massimizzare il livello di sicurezza.



Pallet per il trasporto delle bombole di gas

Pallet per il trasporto di bombole di gas compressi



Modello
PBO 04Z

Modello
PBO 08Z



Modello
PBO 12Z

MODELLO	Numero bombole Ø 230 mm	Misure esterne Larg. x Prof. x Alt. (mm)
PBO 04Z	4	860 x 650 x 1115
PBO 08Z	8	860 x 1170 x 1115
PBO 012Z	12	1030 x 805 x 1225



Dotati di dispositivo di sicurezza a chiusura automatica.
Nel **modello PBO12Z** la rampa di accesso, una volta chiusa, diventa una sponda di protezione.

Pallet per il trasporto delle bombole di gas

Carrelli e supporti per il trasporto di bombole di gas compressi

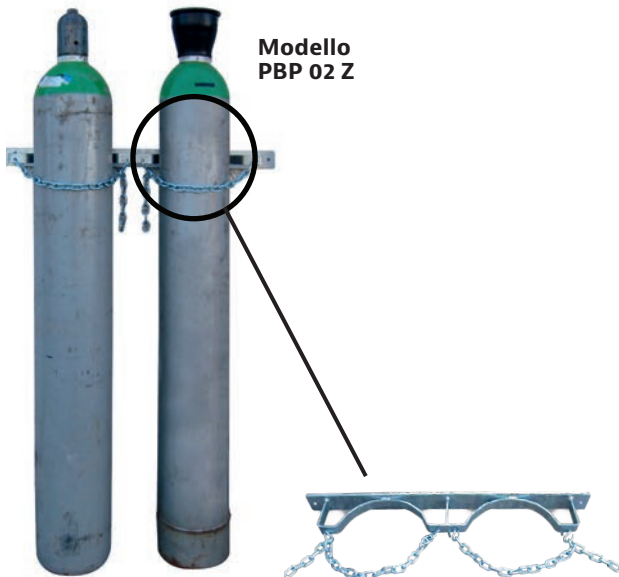

Modello
PBP 02 Z

Supporto a parete
nr. 2 bombole



Modello
CABO 12 RZ

Carrelli in acciaio per bombole

Modello
CABO 23 RZ

MODELLO	Numero bombole Ø 250 mm	Misure esterne Larg. x Prof. x Alt. (mm)
PBP 02 Z	2	860 x 60 x 115
CABO 23 RZ	2	780 x 770 x 1290
CABO 12 RZ	1	490 x 460 x 1260



CONTENITORI PER LA RACCOLTA RIFIUTI

a. **Contenitori porta big bag**

I porta big bag Sall assicurano la massima sicurezza nel riempimento, nella movimentazione e nello stoccaggio di big bag contenenti sia materiali industriali che sostanze e rifiuti pericolosi, come nel caso dei sacconi big bag. Il design sovrapponibile e la struttura smontabile permettono sia l'ottimizzazione dello spazio nello stoccaggio che la minimizzazione dell'ingombro e dei costi di trasporto.



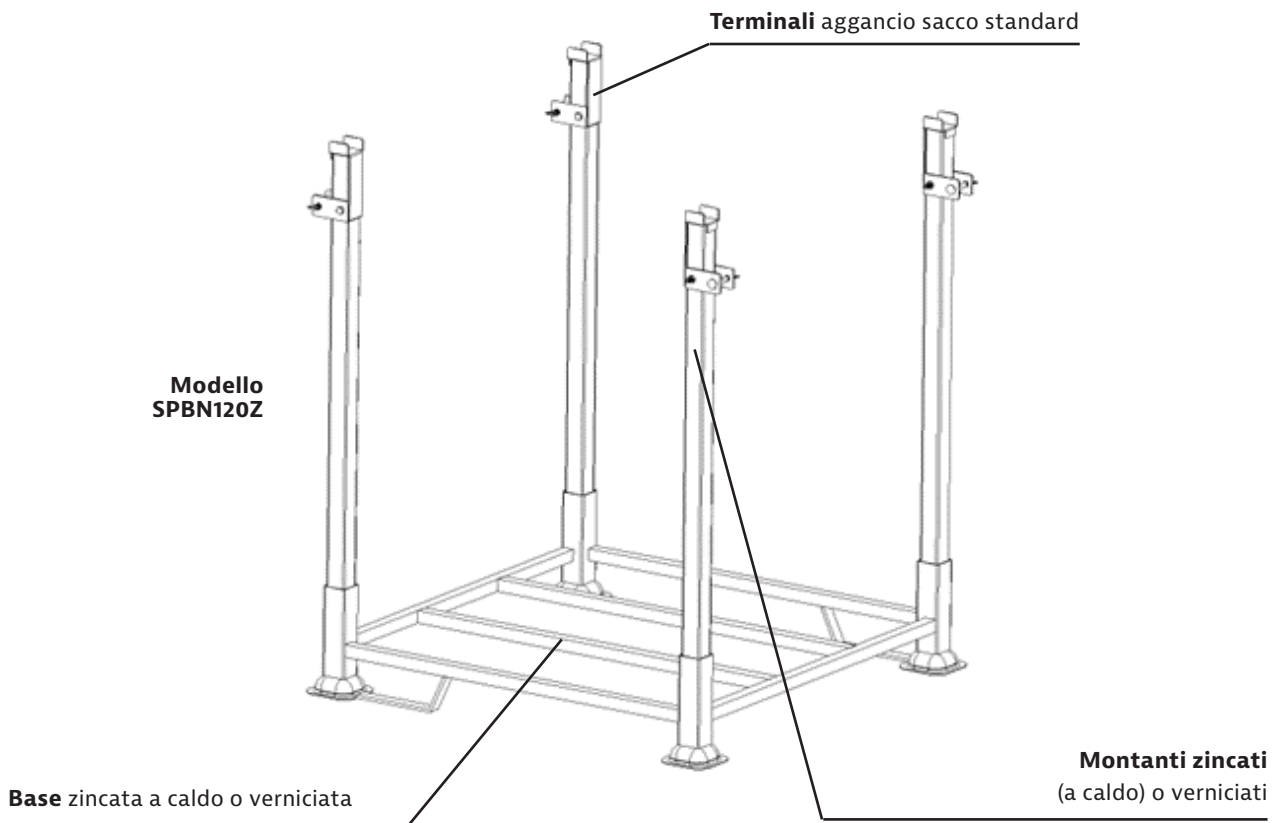

Configurazione standard



MODELLO	Descrizione	Larg. x Prof. x Alt. (mm)	Portata (kg)
SPBN 120 Z	Configurazione standard: 4 terminali aggancio sacco standard + 1 base zincata a caldo o verniciata + 4 montanti zincati (a caldo) o verniciati	1080 x 1080 x 1347	1000



- 1. MANEGGEVOLE**
- 2. CONFIGURABILE** grazie ad una vasta gamma di accessori disponibili (vedi pagina successiva)
- 3. ADATTO SIA ALL'UTILIZZO IN INTERNO CHE IN ESTERNO** grazie alle due versioni disponibili della base (zincata a caldo e/o verniciata a polvere).



Accessori

MODELLO	Descrizione
PALN120	Piano d'appoggio in lamiera
INSPLUS120	Inserto plus con 3 posizioni di aggancio del sacco
SPON120	Fianchetto singolo
INSCAPN120	Terminale aggancio sacco a cappello
ALLN120	Allungo mobile montanti mm 220
PARN120	Piano in rete
CRMN120	Carrello di movimentazione
COPN120	Coperchio mobile in lamiera zincata
VASN120	Vasca mobile

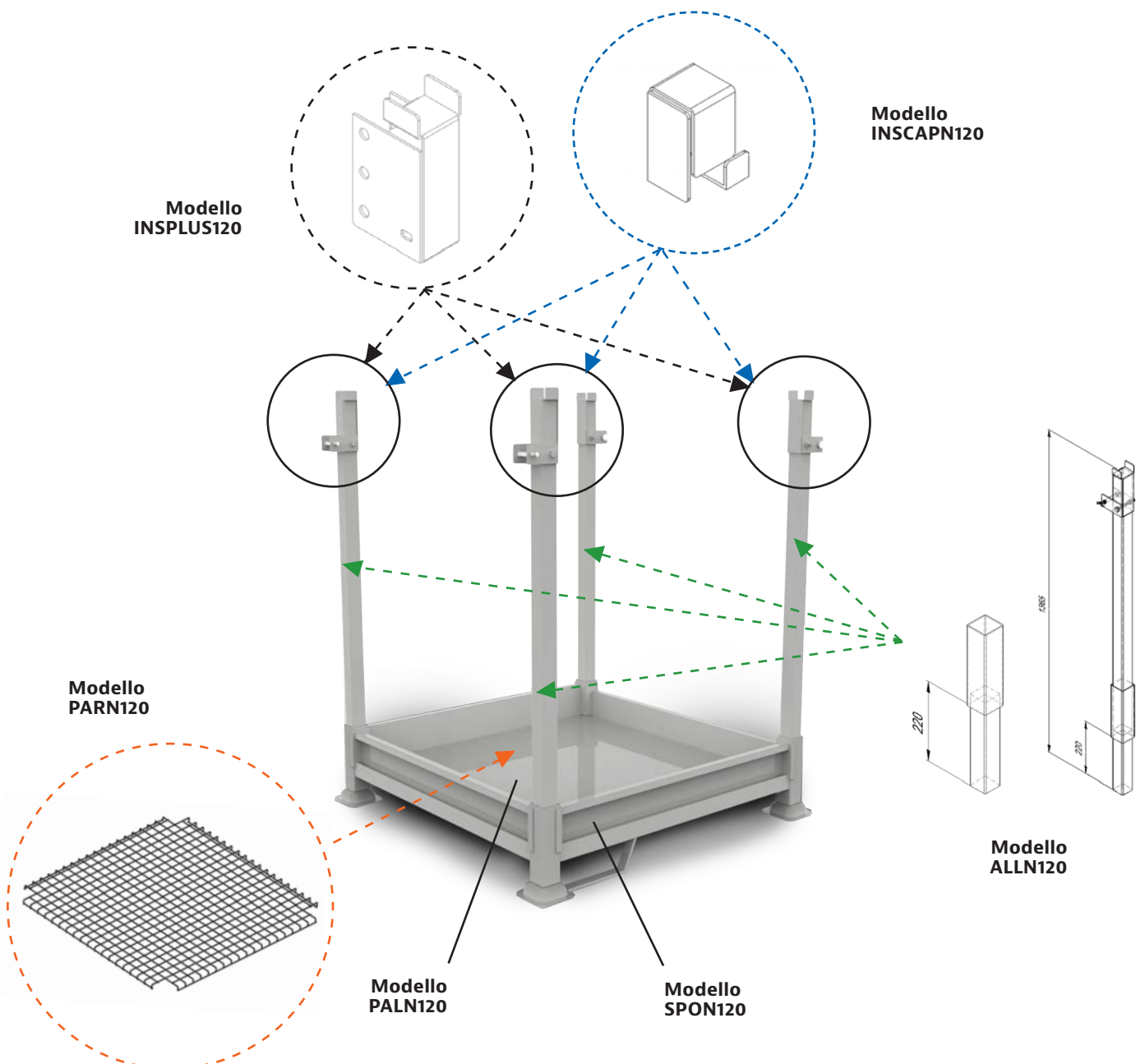

Contenitori porta big bag Pallet porta big bag

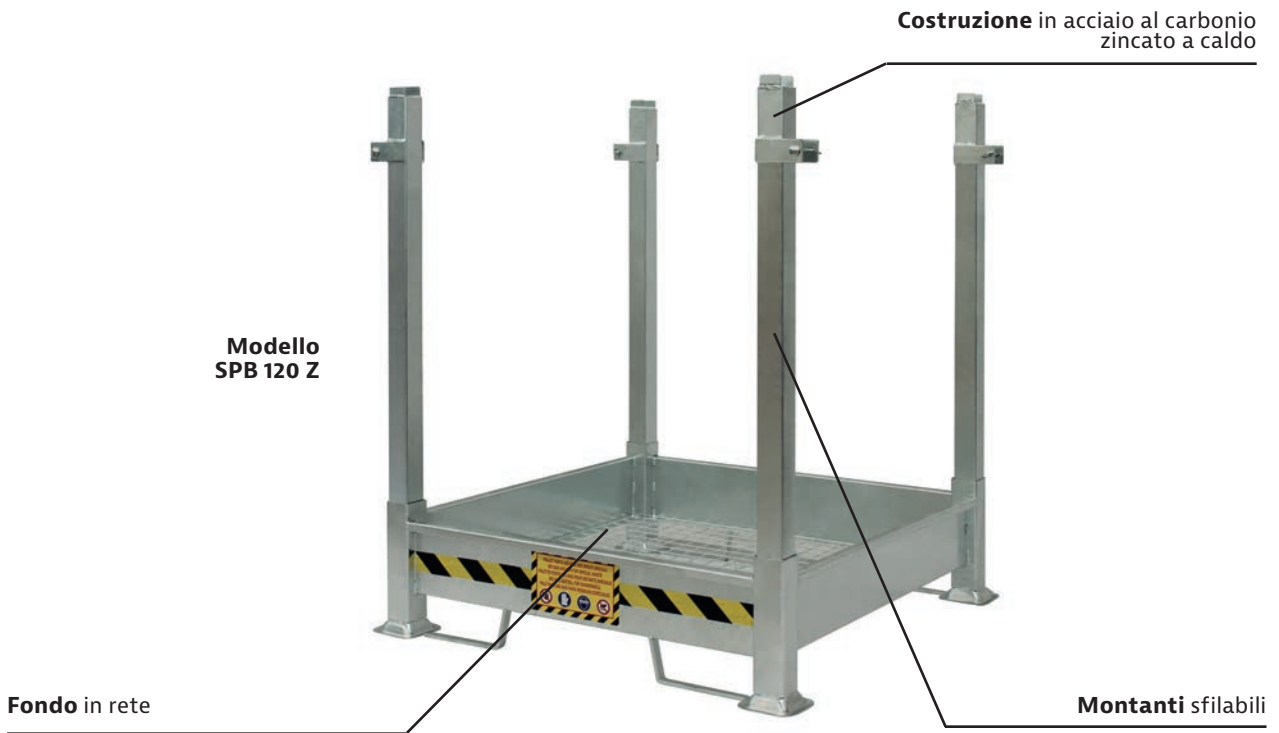

Configurazione standard



MODELLO	Larg. x Prof. x Alt. (mm)	Portata (kg)
SPB 120 Z	1070 x 1070 x 1350	1000

Accessori

MODELLO	Larg. x Prof. x Alt. (mm)	Portata (kg)	Volume litri
BBAG 1000 ONU	900 x 900 x 1200	1000	1000



Disponibile su richiesta:

- Coperchio rimovibile** con maniglie
- Big bag** omologato ONU 3/Y con portata da 1000 Kg (omologazione "R" su fondo giallo come previsto dal D.L. 52 del 03/02/1997, completo di liner interno).



Contenitori porta big bag

Contenitori porta big bag con vasca di raccolta



- Struttura in acciaio al carbonio
- Montanti sfilabili
- Trattamento esterno anticorrosione
- Disponibili su richiesta anche in versione verniciata
- Su richiesta anche nella versione con ruote: 2 fisse e 2 piroettanti con freno (**modello SPB122CR**).



Modello SPB122Z



Modello SPB122CR



MODELLO	Larg. x Prof. x Alt. (mm)	Portata (kg)	Volume litri
SPB122A	1000 x 1000 x 1860	1000	208
SPB122Z	1000 x 1000 x 1860	1000	208
SPB122CRA	1000 x 1000 x 1998	900	208
SPB122CRZ	1000 x 1000 x 1998	900	208

Contenitori porta big bag

Contenitori porta big bag con coperchio



Pistoni a gas
per servoassistere il
portellone superiore
incernierato

Modello SPB121



MODELLO	Misure esterne Larg. x Prof. x Alt. (mm)	Portata (kg)
SPB121	1100 x 1100 x 1360	1000



- Ideale per lo stoccaggio temporaneo di scarti
- Realizzato con pianta quadrangolare, carenatura portante in acciaio al carbonio
- Disponibili su richiesta etichettatura e simbologia di sicurezza per l'identificazione del prodotto.

INDICE PRODOTTI

A			
ALLN120	pag. 47		
B			
B120G30	pag. 42		
B60G30	pag. 42		
BBAG1000ONU	pag. 48		
C			
CABO12RZ	pag. 44		
CABO23RZ	pag. 44		
CO60-380	pag. 9		
COPN120	pag. 47		
CRMN120	pag. 47		
D			
DIAM125BP	pag. 42		
E			
ESTINTORE	pag. 42		
I			
INSCAPN120	pag. 47		
INSPLUS120	pag. 47		
L			
LT0280	pag. 8		
LT0300	pag. 8		
LT0450	pag. 10		
LT0460	pag. 10		
LT0470	pag. 10		
LT0500	pag. 8		
LT0750	pag. 8		
LT1000	pag. 8		
LT1350	pag. 8		
LT1600	pag. 8		
LT2000	pag. 8		
LTR1350	pag. 12		
LTR1600	pag. 12		
LTR2000	pag. 12		
M			
MSH 14	pag. 18-19-20-21	MSH 35	pag. 18-19-20-21
MSH 15	pag. 18-19-20-21	MSH 36	pag. 18-19-20-21
MSH 24	pag. 18-19-20-21	MSH 38	pag. 18-19-20-21
MSH 25	pag. 18-19-20-21	MSH 410	pag. 18-19-20-21
MSH 26	pag. 18-19-20-21	MSH 44	pag. 18-19-20-21
MSH 28	pag. 18-19-20-21	MSH 45	pag. 18-19-20-21
MSH 34	pag. 18-19-20-21	MSH 46	pag. 18-19-20-21
		MSH 48	pag. 18-19-20-21
		MSH 510	pag. 18-19-20-21
		MSH 54	pag. 18-19-20-21
		MSH 55	pag. 18-19-20-21
		MSH 56	pag. 18-19-20-21
		MSH 58	pag. 18-19-20-21
		MSH 610	pag. 18-19-20-21
		MSH 64	pag. 18-19-20-21
		MSH 65	pag. 18-19-20-21
		MSH 66	pag. 18-19-20-21
		MSH 68	pag. 18-19-20-21
		MSL 14	pag. 18-19-20-21
		MSL 15	pag. 18-19-20-21
		MSL 24	pag. 18-19-20-21
		MSL 25	pag. 18-19-20-21
		MSL 26	pag. 18-19-20-21
		MSL 28	pag. 18-19-20-21
		MSL 34	pag. 18-19-20-21
		MSL 35	pag. 18-19-20-21
		MSL 36	pag. 18-19-20-21
		MSL 38	pag. 18-19-20-21
		MSL 410	pag. 18-19-20-21
		MSL 44	pag. 18-19-20-21
		MSL 45	pag. 18-19-20-21
		MSL 46	pag. 18-19-20-21
		MSL 48	pag. 18-19-20-21
		MSL 510	pag. 18-19-20-21
		MSL 54	pag. 18-19-20-21
		MSL 55	pag. 18-19-20-21
		MSL 56	pag. 18-19-20-21
		MSL 58	pag. 18-19-20-21
		MSL 610	pag. 18-19-20-21
		MSL 64	pag. 18-19-20-21
		MSL 65	pag. 18-19-20-21
		MSL 66	pag. 18-19-20-21
		MSL 68	pag. 18-19-20-21
		MSM 14	pag. 18-19-20-21
		MSM 15	pag. 18-19-20-21
		MSM 24	pag. 18-19-20-21
		MSM 25	pag. 18-19-20-21
		MSM 26	pag. 18-19-20-21
		MSM 28	pag. 18-19-20-21
		MSM 34	pag. 18-19-20-21
		MSM 35	pag. 18-19-20-21
		MSM 36	pag. 18-19-20-21
		MSM 38	pag. 18-19-20-21
		MSM 410	pag. 18-19-20-21
		MSM 44	pag. 18-19-20-21
		MSM 45	pag. 18-19-20-21
		MSM 46	pag. 18-19-20-21
		MSM 48	pag. 18-19-20-21
		MSM 510	pag. 18-19-20-21
		MSM 54	pag. 18-19-20-21
		MSM 55	pag. 18-19-20-21
		MSM 56	pag. 18-19-20-21
		MSM 58	pag. 18-19-20-21
		MSM 610	pag. 18-19-20-21
		MSM 64	pag. 18-19-20-21
		MSM 65	pag. 18-19-20-21
		MSM 66	pag. 18-19-20-21
		MSM 68	pag. 18-19-20-21
		P	
		PALN120	pag. 47
		PANDESA10	pag. 41
		PANDESA3	pag. 41
		PANDESA6	pag. 41
		PANDESA6+3	pag. 41
		PARN120	pag. 47
		PBO011CBZ	pag. 42
		PBO011CBZ/1R	pag. 42
		PBO04Z	pag. 44
		PBO08Z	pag. 44
		PBO12Z	pag. 44
		PBO15CBZ	pag. 41
		PBO15SBZ	pag. 41
		PBO23CBZ	pag. 42
		PBO30CBZ	pag. 41
		PBO30SBZ	pag. 41
		PBO35CBZ	pag. 42
		PBP02Z	pag. 44
		PCLI/310210Z	pag. 30
		R	
		RSOL	pag. 42
		S	
		SDC1000	pag. 12
		SDC550	pag. 12
		SDC750	pag. 12
		SL011	pag. 22
		SL018	pag. 22
		SL047CR	pag. 29
		SL064H1000	pag. 16
		SL064H1300	pag. 16
		SL064H650	pag. 16
		SL083	pag. 22
		SL084	pag. 22
		SL130	pag. 22
		SL150AP	pag. 15
		SL150AR	pag. 15
		SL150BP	pag. 15
		SL150BR	pag. 15
		SL150CP	pag. 15
		SL150CR	pag. 15
		SL153A	pag. 16
		SL153B	pag. 16
		SL154A	pag. 15
		SL154B	pag. 15
		SL154C	pag. 15
		SL159	pag. 23
		SL160	pag. 23
		SL161	pag. 23
		SL162	pag. 23
		SL164R	pag. 13

SL165P pag. 13
SL165PCR pag. 13
SL167CR pag. 13
SL201 pag. 22
SL406M pag. 22
SL406P pag. 22
SL407M pag. 22
SL407P pag. 22
SLC400 pag. 23
SLC800 pag. 23
SP049 pag. 33
SP050 pag. 33
SP051 pag. 33
SP052 pag. 34
SP053 pag. 33
SP054 pag. 33
SP055 pag. 35
SP056 pag. 35
SP056L pag. 35
SP060 pag. 38
SP061 pag. 39
SP062 pag. 38
SP063 pag. 39
SP068 pag. 38
SP069 pag. 39
SP070 pag. 38
SP071 pag. 38
SP072 pag. 38
SP073 pag. 39
SP074 pag. 39
SP075 pag. 39
SP11493 pag. 34
SP139 pag. 33
SP140 pag. 33
SP141 pag. 33
SP142 pag. 33
SP143 pag. 33
SP144 pag. 33
SP145 pag. 34
SP146 pag. 34
SP147 pag. 34
SP149 pag. 36
SP151 pag. 36
SP157 pag. 36
SP158 pag. 36
SP180 pag. 33
SP181 pag. 33
SP182 pag. 33
SP183 pag. 33
SP184 pag. 33
SP185 pag. 33
SP186 pag. 33
SP211 pag. 33
SP212 pag. 33
SP213 pag. 33
SP214 pag. 33
SP215 pag. 33
SP6000 pag. 35
SPAB215 pag. 36
SPB120Z pag. 48
SPB121 pag. 49
SPB122A pag. 49
SPB122CRA pag. 49
SPB122CRZ pag. 49

SPB122Z pag. 49
SPBN120Z pag. 46
SPN060 pag. 38
SPN061 pag. 39
SPN062 pag. 38
SPN063 pag. 39
SPN068 pag. 38
SPN069 pag. 39
SPN070 pag. 38
SPN071 pag. 38
SPN072 pag. 38
SPON120 pag. 47
SR047CR pag. 29
SR12815 pag. 30
SR128CR pag. 29
SR129CR pag. 29
SR156 pag. 30
SR159 pag. 30
SR160 pag. 30
SR161 pag. 30
SR162 pag. 30
SR163 pag. 31
SR163CR pag. 31
ST134 pag. 29
ST135 pag. 29
ST136 pag. 29
ST137 pag. 29
ST138 pag. 29

V

VASN120 pag. 47
VR pag. 11

W

WSH 14 pag. 25-26-27-28
WSH 15 pag. 25-26-27-28
WSH 24 pag. 25-26-27-28
WSH 25 pag. 25-26-27-28
WSH 26 pag. 25-26-27-28
WSH 28 pag. 25-26-27-28
WSH 34 pag. 25-26-27-28
WSH 35 pag. 25-26-27-28
WSH 36 pag. 25-26-27-28
WSH 38 pag. 25-26-27-28
WSH 410 pag. 25-26-27-28
WSH 44 pag. 25-26-27-28
WSH 45 pag. 25-26-27-28
WSH 46 pag. 25-26-27-28
WSH 48 pag. 25-26-27-28
WSH 510 pag. 25-26-27-28
WSH 54 pag. 25-26-27-28
WSH 55 pag. 25-26-27-28
WSH 56 pag. 25-26-27-28
WSH 58 pag. 25-26-27-28
WSH 610 pag. 25-26-27-28
WSH 64 pag. 25-26-27-28
WSH 65 pag. 25-26-27-28
WSH 66 pag. 25-26-27-28
WSH 68 pag. 25-26-27-28
WSL 14 pag. 25-26-27-28

WSL 15 pag. 25-26-27-28
WSL 24 pag. 25-26-27-28
WSL 25 pag. 25-26-27-28
WSL 26 pag. 25-26-27-28
WSL 28 pag. 25-26-27-28
WSL 34 pag. 25-26-27-28
WSL 35 pag. 25-26-27-28
WSL 36 pag. 25-26-27-28
WSL 38 pag. 25-26-27-28
WSL 410 pag. 25-26-27-28
WSL 44 pag. 25-26-27-28
WSL 45 pag. 25-26-27-28
WSL 46 pag. 25-26-27-28
WSL 48 pag. 25-26-27-28
WSL 510 pag. 25-26-27-28
WSL 54 pag. 25-26-27-28
WSL 55 pag. 25-26-27-28
WSL 56 pag. 25-26-27-28
WSL 58 pag. 25-26-27-28
WSL 610 pag. 25-26-27-28
WSL 64 pag. 25-26-27-28
WSL 65 pag. 25-26-27-28
WSL 66 pag. 25-26-27-28
WSL 68 pag. 25-26-27-28
WSM 14 pag. 25-26-27-28
WSM 15 pag. 25-26-27-28
WSM 24 pag. 25-26-27-28
WSM 25 pag. 25-26-27-28
WSM 26 pag. 25-26-27-28
WSM 28 pag. 25-26-27-28
WSM 34 pag. 25-26-27-28
WSM 35 pag. 25-26-27-28
WSM 36 pag. 25-26-27-28
WSM 38 pag. 25-26-27-28
WSM 410 pag. 25-26-27-28
WSM 44 pag. 25-26-27-28
WSM 45 pag. 25-26-27-28
WSM 46 pag. 25-26-27-28
WSM 48 pag. 25-26-27-28
WSM 510 pag. 25-26-27-28
WSM 54 pag. 25-26-27-28
WSM 55 pag. 25-26-27-28
WSM 56 pag. 25-26-27-28
WSM 58 pag. 25-26-27-28
WSM 610 pag. 25-26-27-28
WSM 64 pag. 25-26-27-28
WSM 65 pag. 25-26-27-28
WSM 66 pag. 25-26-27-28
WSM 68 pag. 25-26-27-28







JUSTRITE ITALIA Srl
Via dei Prati Vecchi, 37 - 42025 Cavriago (RE)
Tel. +39 0522 941430 - info@sall.it - www.sall.it